

Town of Ross

DESIGN GUIDELINES

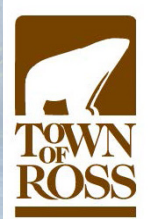

Adopted June 13, 2019

Acknowledgements

Town of Ross Advisory Design Review Group (ADR Group)

Josefa Buckingham
Mark Fritts
Mark Kruttschnitt
Stephen Sutro
Dan Winey

Town Council

P. Beach Kuhl, Mayor
Elizabeth Brekhus, Mayor Pro Tempore
Julie McMillan, Council Member
Elizabeth Robbins, Council Member
P. Rupert Russell, Council Member

Town Staff

Heidi Scoble, Planning and Building Director

Consultant Team

Winter & Company
3980 Broadway
Suite 103, PMB 140
Boulder, CO 80304

Scott Lewis Landscape Architecture
601 Montgomery Street, Suite 500
San Francisco, CA 94111



Introduction	1
Excellence of Design	2
Considering Context in Design	2
Advisory Design Review Group	3
Why Have Design Guidelines?	3
The Design Review Process	4
Using the Design Guidelines	5
Town of Ross Character	7
Ross Contexts	7
Character Drivers	11
Townwide Character Analysis	18
Factors That May Influence the Importance of the Design Topics	21
Overarching Design Principles	23
Maintain the “Small-Town” Feel	24
Provide Excellence in Design	24
Contribute to the Landscape	24
Design in Harmony with Nature	24
Design Buildings to Fit the Community	24
Respect Neighboring Properties and Prioritize Privacy	25
Encourage Sustainable Development	25
Protect Important Views	26
Respect Heritage Resources	26
Promote Public and Personal Safety in Design	26

Table of Contents

Site Design Guidelines	27
Introduction	27
Designing with Topography	28
Primary Building Placement	29
Primary Building Orientation	30
Secondary Structures and Accessory Dwelling Unit (ADU) Placement	31
Site Connections	38
Street Edge and Front Yard Design	41
Side Yard Relationship	54
Retaining Walls	55
Hardscape Materials	56
Site Lighting	57
Sustainability and Design	58
Low Impact Development (LID)	62
Building Design Guidelines	63
Introduction	63
Building Mass, Scale and Articulation	64
Roof Form	68
Materials and Color Palette	69
Facade Design	70
Secondary Structure and ADU Design	76
Sustainable Building Design	77
Treatment of Heritage Resources	79
Heritage Preservation Principles and Best Practices	80
Approaches to Heritage Preservation Projects	82
Guidelines for the Treatment of Heritage Building Features	83

CHAPTER 1

INTRODUCTION



The Town of Ross is a special place in an extraordinary setting with significant natural resources, high quality architecture and a strong community identity. Residents value its traditional character, small-town charm, tree-lined streets, wooded hillsides and meandering creeks. Ross continues to attract investment in its neighborhoods, through alterations and improvements to existing buildings as well as new construction. How can these changes be accommodated while respecting the design traditions of Ross? These design guidelines provide a tool to assist in achieving compatible development, while accommodating high quality, innovative design.

The Ross General Plan 2007-2025 addresses those values and states:

“We want Ross to retain these attributes and still be a dynamic and evolving community.”

It also specifically calls for developing design guidelines. In response to that directive, this document provides design guidelines for all residential areas in town. And, while it does not provide specific guidelines for commercial areas, it does set forth a set of high-level design principles that can apply throughout the community, for both residential and commercial development.

In This Chapter

Excellence of Design	2
Considering Context in Design	2
Advisory Design Review Group	3
Why Have Design Guidelines?	3
The Design Review Process	4
Using the Design Guidelines	5



Excellence of Design

A key section of the General Plan focuses on “Excellence of Design” and sets forth an important goal that underlies the principles and guidelines that appear in this document:

Design With Nature, Neighborhood and Community

Ross encourages architectural variety of buildings and the open feeling of the Town. Buildings recede into the background while landscaping and open space take center stage. Ross’s neighborhoods mix old and new construction through the use of appropriate building materials and landscaping, and through the appropriate design, scale, architectural detailing and siting of improvements. We have come to expect an excellence of design that blends with the neighborhood setting.

This goal provides the basis for ten Design Principles set forth in this document. These in turn are implemented through the design guidelines that follow.

Considering Context in Design

The General Plan also recognizes that conditions influencing compatibility vary throughout the community. It notes that sites on hillsides need special consideration, and that the context varies by the degree of the slope and the character of the road edge. In response to this, a series of Design Contexts are described in this document, followed by a description of Character Drivers that will help explain how context plays a role in determining appropriateness of design.

Advisory Design Review Group

Chapter 18.141 of the Town's development code establishes design review requirements. These extend to a wide range of improvements, including new construction, and many types of building additions and alterations, as well as various types of site work, and landscaping. The Town Council is the formal review authority. In advance of their consideration, design review is conducted by Town staff and an Advisory Design Review (ADR) Group. The ADR Group provides professional review of design-related issues, including site planning, building massing, setbacks, light and air, and privacy, as well as architectural details and materials selection. The objective of the process is to provide applicants with helpful advice early in the review process and to offer an opportunity for neighbor input and feedback. The professional design suggestions and solutions are provided in an informal setting conducive to dialogue and collaborative problem-solving. The goal is to ensure the context of a project is appropriate for both the Town and the particular neighborhood.

Section 18.41.100 of the Town Code sets forth design review criteria and standards for a wide range of design topics. This design guidelines document provides supplemental material to assist in applying those criteria and standards.

Why Have Design Guidelines?

The design guidelines in this document provide a basis for making consistent decisions about the appropriateness of new development and improvements to existing properties that are subject to the Town's Design Review process. This document helps articulate the community's expectations for design. In addition, this document serves as an educational and planning tool for property owners, design professionals and decision makers.

When is Design Review Required?

As identified in the Ross Design Review Ordinance (Chapter 18.41), improvements requiring design review include:

- All new buildings
- All exterior remodeling resulting in additions, extensions or enlargements to existing buildings exceeding two hundred square feet of new floor area
- All fences, gates or walls, or a combination of these, greater than forty-eight inches in height in any yard adjacent to the street or right-of-way
- Any project resulting in the removal or alteration of more than twenty-five percent of the exterior walls or wall coverings of a residence
- Any activity or project resulting in more than fifty cubic yards of grading or filling
- Any construction, improvements, grading/filling or other site work within twenty-five feet of a creek, waterway or drainageway
- Any project resulting in over 1,000 square feet of new impervious landscape surface

Please see the Ross Design Review Ordinance for the full list of improvements requiring design review.

Design Review and Other Town Regulations

Note that other town regulations and those of other authorities with jurisdiction over some categories of development in Ross may at times conflict with some of the design guidelines in this document or may cause creative solutions. For example, regulations continue to evolve related to fire safety and flood hazard mitigation. These conditions may cause some adjustment to the expectations of the design guidelines. For example, new regulations focusing on reducing wildfire hazard may limit landscape designs that could conflict with some of the images for landscaping concepts in the design guidelines. Focusing on the intent statements that are included among the guidelines will be important in those cases.

The Design Review Process

These are the steps in securing design review approval:

- 1. Meet with Town staff early in project**
 Discuss the general approach and application of the design guidelines.
- 2. Prepare the design proposal**
 Provide sufficient information to enable informed decision-making. Staff will review the application for completeness and place the project on the agenda for an ADR meeting.
- 3. Meet with the ADR Group**
 Together with the applicant, ADR will discuss the project, including the site plan, architectural plans, landscape plans and materials. The ADR Group will suggest modifications as appropriate and will make a formal recommendation.
- 4. Staff prepares a report**
 The report will highlight how the project complies with the design guidelines and address any issues that the ADR may have raised.
- 5. Attend the Town Council hearing**
 The Town Council will consider the staff report with the ADR recommendations and act on the proposal.

Type of Work:

Chapter to Use:

	Introduction	Town of Ross Character	Overarching Design Principles	Site Design Guidelines	Building Design Guidelines	Treatment of Heritage Resources
Site Work	✓	✓	✓	✓	-	-
Construct a new building	✓	✓	✓	✓	✓	-
Adding on to an existing building	✓	✓	✓	-	✓	-
Major renovations to an existing building	✓	✓	✓	-	✓	-
Work on a Heritage Property	✓	✓	✓	✓	✓	✓*

*The Treatment of Heritage Resources guidelines are informational; compliance with this chapter is not required.

Using the Design Guidelines

The design guidelines are grouped into topics that are introduced with intent statements that can be used in evaluating projects when the direct interpretation of specific guidelines may be uncertain. This material, along with the guidelines statements themselves and associated imagery may be used in determining appropriateness. The format is explained below.

Figure 1.1: SAMPLE DESIGN GUIDELINE

<p>A Design Topic Describes the topic area that the design guidelines fall within.</p>	<h2>Building Placement</h2>
<p>B Intent Statement Explains the desired outcome and provides a basis for the subsequent guidelines. The intent statement is the most important component for each design topic and may be met in ways other than the design guidelines. If no guidelines address a specific design issue, the intent statement will be used to determine appropriateness.</p>	<p>A building should be placed in a way that is considerate of its context. Where there is an established pattern of building setbacks, such as in the Constrained Grid Neighborhood context, a new building should be placed to align with the existing buildings and reflect the pattern on the block. Where there is no established setback pattern or a pattern that provides flexibility in setback on the site, buildings should be placed in a way that fits with the topography of the site.</p>
<p>C Design Guideline Describes the design outcome. Guidelines are sequentially numbered in each chapter.</p>	<p>1. <i>Locate a building within the range of established setbacks on a block.</i></p>
<p>D Additional Information Provides bullet lists of appropriate and inappropriate strategies for meeting the intent of the guideline.</p>	<p>a. Where front yard setbacks are uniform, align a new building with its neighboring buildings.</p>
<p>E Context Specific Statements Call-outs identify when a design guideline is especially important for a Character Area.</p>	<p>* This is particularly important in Character Area 1, where traditional residential buildings comprise the majority of development.</p>
<p>F Images Clarify the intent of the guideline by illustrating appropriate and inappropriate design solutions.</p>	 <p>Locate a building within the range of established setbacks on a block.</p>
<p>✓ Appropriate Images marked with a check illustrate appropriate design solutions.</p>	
<p>X Inappropriate Images marked with an X illustrate inappropriate design solutions.</p>	



CHAPTER 2

TOWN OF ROSS CHARACTER



Understanding the design character of Ross begins with a consideration of features that contribute to the town’s distinct identity. Residents value its architectural heritage and many styles. Natural features, roadways and landscapes also contribute to Ross’s distinct character. This chapter summarizes the town’s character at a broad level and then discusses the factors that influence character at neighborhood, site and building levels.

In This Chapter

Ross Contexts	7
Character Drivers	11
Townwide Character Analysis	18
Factors That May Influence the Importance of the Design Topics	21

Ross Contexts

While diversity in design is a signature feature throughout Town, sub-areas exist that demonstrate consistency of certain features. These are considered different “contexts.” A map appears on page 10 that identifies six different contexts. Note that boundaries are not sharply defined, because factors that contribute to context can change in very subtle ways.

The following context descriptions should be used in conjunction with the guidelines. The context areas serve as a general guide for considering how the design guidelines may apply to different settings. For example, some building design guidelines may be interpreted with more flexibility when the building is not visible from the street. Where a particular design topic or individual guideline is especially relevant for a specific context, it is noted in the guidelines.



Major Arterial Corridor



Constrained Grid Neighborhood



Strong Street Relationship/Flat



Moderate Street Relationship/Flat and Mild Slope

Major Arterial Corridor

This area is strongly influenced by Sir Francis Drake Boulevard and Corte Madera Creek. Most properties are visually separated from the road with fences and gates. Most are connected to the street by walkways or gated vehicular entries. Because of the close proximity to the street, front yard landscaping often is defined by tall hedges and walls.

Constrained Grid Neighborhood

This area has small lots and a tight street system. Buildings often are very close to the street and have a street presence through defined entryways.

Buildings are located near the street and have entrances directly facing the street. Building fronts are parallel to the street, and have doors and windows that face the sidewalk. Landscaping on these properties is layered with a pathway, gate or similar feature.

Examples occur along Bolinas and Poplar Avenues.

Strong Street Relationship/Flat

In these areas, entries to homes are highly visible and houses have a consistent pattern of uniform setbacks and street orientation. A walkway typically provides a physical connection to the public realm. In some cases, on-street parking creates a somewhat more formal road edge.

Sometimes a home may not be sited parallel to the street, but it is connected to it with a pathway. Landscaping may highlight that path.

These areas exist along Bolinas, Poplar and Wellington Avenues.

Moderate Street Relationship/Flat and Mild Slope

Properties in these areas have a fairly strong relationship with the street. Typically, houses are visible, but not as strongly oriented to the street as in some other areas. Winding roads create some differences in building placement and orientation, although some degree of consistency exists.

This area has a mixture of house placements. Some are oriented to the street and some are placed farther back from the public right of way. Topography may be a driver of building placement.

These areas exist on streets such as Fernhill Avenue, Lagunitas Road and Shady Lane.

Minor Street Relationship/Moderate Slope

In these areas, steep topography often results in winding, narrow roads. Houses are somewhat, but not fully, visible from the street and are set back significantly.

These areas often have thick vegetation that obscures houses from the street. In some cases, a pedestrian pathway leads from the public right of way to the entrance of the building. Driveways may be gated but are separated from the street by grade.

These areas exist along Glenwood Avenue, Lagunitas Road and Ivy Drive.



Minor Street Relationship/Moderate Slope

Entry Element Street Relationship/Significant Slope

Steep topography is the dominant driver of character in these areas. Typically, a house is substantially separated from the public right of way. The view to it is often obscured by a steep slope and extensive vegetation. A driveway is typically the only connection between a house and the street. At the road edge, landscaping, fences and walks profoundly impact character.

Few properties in these areas are visible from the street. Many are uphill, with a driveway leading to the home. Others are downhill, with portions of buildings visible from the street. The relationship of these buildings with the street is minimal. Even though this context is currently characterized by homes located far back into the site and typically not visible from the street, the preferred location for homes is closer to the street so they have a stronger street presence. New fire safety standards also will affect future character.

These areas exist on streets such as Upper Road, Chestnut Avenue and Crest Road.



Entry Element Street Relationship/Significant Slope

Figure 2.1: DESIGN CONTEXTS

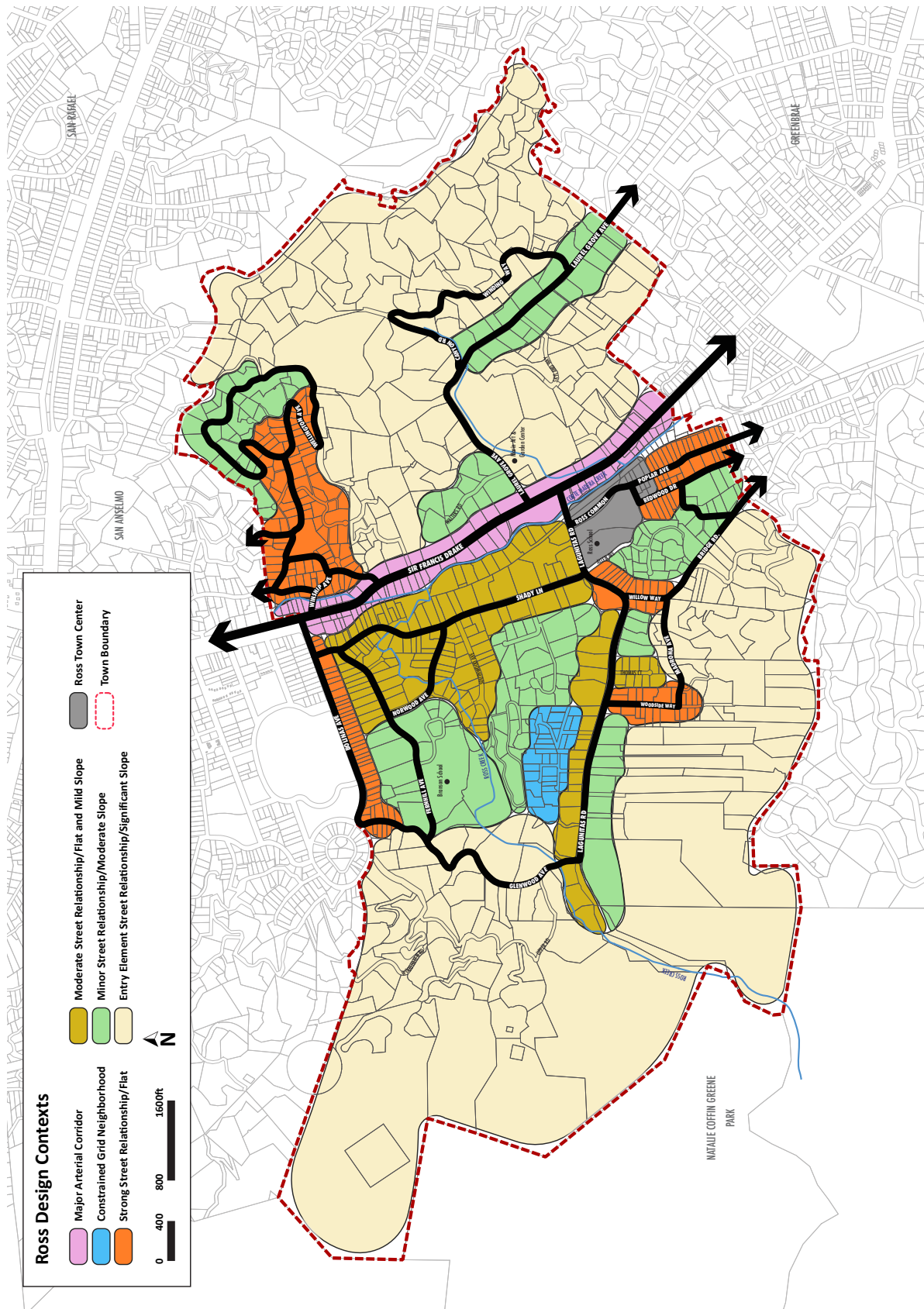

Character Drivers

This section describes some of the individual elements that influence physical character in Ross. These may be considered at three levels of perception: (1) neighborhood, (2) site and (3) building - as described below. Photos illustrate character-influencing elements at these three levels.

With its rich diversity of high quality design, there are some features that are consistent throughout the community. Other features appear in some areas, but not others. These contribute to the distinctive features of individual neighborhoods.

NEIGHBORHOOD LEVEL

Character drivers at a neighborhood level typically span multiple properties along a street. These features impact groups of properties, but also each individual one. Variables include the degree of topography, the type of pedestrian facilities provided along the street and the width of the roadway. Many neighborhood level characteristics are shaped by the qualities of the public right of way and the natural landscape.

SITE LEVEL

Site level character drivers are perceived on a property-by-property basis. These include how a building is placed relative to the street, the design of an entry, front yard landscape and driveway design. While site level characteristics are uniquely arranged on each individual property, there are some streets where many properties share similar site level characteristics.

BUILDING LEVEL

Building level character drivers also are perceived on a site-by-site basis. These include the form and massing of a building, its materials and the design of individual elements such as windows, doors and porches. Building level characteristics also are unique to an individual property, but there are some areas where many properties share common characteristics at a building level.



NEIGHBORHOOD LEVEL CHARACTER DRIVERS

STEEP TOPOGRAPHY/NATURAL STREET EDGE



Topography

- Steep topography partially obscures houses
- Hills and dropoffs create shorter views along the street

Streetscape Character

- The street edge is relatively natural, with informal landscaping
- No formal walkway
- The street is narrow with no shoulder or formal lanes

Contexts Where This Condition Exists

- Entry Element Street Relationship/Significant Slope
- Minor Street Relationship/Moderate Slope
- Streets including: Upper Road, Chestnut Avenue, Crest Road

FLAT TOPOGRAPHY/FORMAL STREET EDGE



Topography

- Flat topography affords longer views along the block

Streetscape Character

- The street edge gradually transitions from the public realm to the private realm
- Front yard landscaping offers visual interest from the street
- A formal sidewalk provides pedestrian access

Contexts Where This Condition Exists

- Strong Street Relationship/Flat Neighborhood
- Constrained Grid
- Moderate Street Relationship/Flat and Mild Slope
- Streets including: Bolinas Avenue, Poplar Avenue, Wellington Avenue

NEIGHBORHOOD LEVEL CHARACTER DRIVERS

**MODERATELY VARIED TOPOGRAPHY/
MODERATELY FORMAL STREET EDGE**



Topography

- Moderately varied topography creates shorter views along the street

Streetscape Character

- The street edge has an informal shoulder
- Gentle transitions to the private realm occur with semi-permeable landscaping leading to a tall, opaque fence
- There is a formal pedestrian walkway along the street

Contexts Where This Condition Exists

- Moderate Street Relationship/ Flat and Mild Slope
- Minor Street Relationship/ Moderate Slope
- Streets including: Fernhill Avenue, Lagunitas Road, Shady Lane

**STEEP TOPOGRAPHY/
MODERATELY FORMAL STREET EDGE**



Topography

- Steep topography partially obscures houses and creates shorter views along the street

Streetscape Character

- The street edge has an informal shoulder
- There is a distinct transition to the private realm sometimes with a low, transparent fence
- The street is narrow with no formal lanes

Contexts Where This Condition Exists

- Moderate Street Relationship/ Flat and Mild Slope
- Major Arterial Corridor
- Streets including: Lagunitas Road, Glenwood Avenue, Ivy Drive

SITE LEVEL CHARACTER DRIVERS

STRONG STREET ORIENTATION/CONNECTION



Building Placement and Orientation

- Building is placed close to the street and consistent with neighboring buildings
- Building is oriented to the street with a street-facing entry

Front Yard Design & Street Connection

- Front edge is defined with visually permeable plantings and a low fence
- Building is connected to street by a driveway and a walkway

Garage Location

- Garage is located behind the house (not pictured) and accessed from the street

Contexts Where This Condition Exists

- Strong Street Relationship/Flat
- Constrained Grid Neighborhood
- Moderate Street Relationship/Flat and Mild Slope
- Streets including: Bolinas Avenue, Poplar Avenue, Wellington Avenue

MODERATE STREET ORIENTATION/ MINIMUM STREET CONNECTION

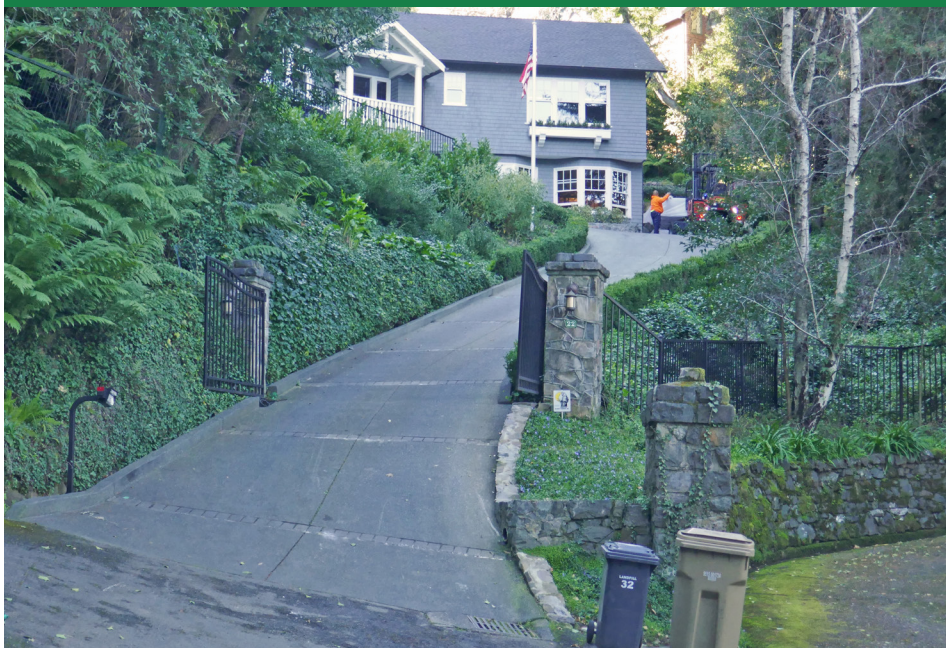

Building Placement and Orientation

- Building is placed back from the street, varied from neighboring buildings
- Building is generally oriented to the street

Front Yard Design & Street Connection

- Edge character is defined by significant topography, extensive landscaping and retaining walls
- Minimum connection to the street (driveway and gate only)
- Fencing is permeable and articulated with sections at different angles

Contexts Where This Condition Exists

- Entry Element Street Relationship/Significant Slope
- Minor Street Relationship/Moderate Slope
- Streets including: Upper Road, Chestnut Avenue, Winding Way

SITE LEVEL CHARACTER DRIVERS

STRONG STREET ORIENTATION/ MODERATE STREET CONNECTION



Building Placement and Orientation

- Building is placed close to the street
- Edge character is defined by a high, visually impermeable fence

Front Yard Design & Street Connection

- Building is connected to street by a driveway that is shared with pedestrians

Garage Location

- Garage is located at the front of the house and accessed from the street, but is facing away from the street which reduces its visibility

Contexts Where This Condition Exists

- Strong Street Relationship/Flat Neighborhood
- Streets including: Lagunitas Road, Shady Lane, Sir Francis Drake Boulevard

MINIMAL STREET ORIENTATION/ MODERATE STREET CONNECTION



Building Placement and Orientation

- Building is placed back from the street
- Edge character is defined by fencing and landscaping, but there is some visual permeability

Front Yard Design & Street Connection

- Building is connected to street by a pedestrian gate and driveway

Contexts Where This Condition Exists

- Entry Element Street Relationship/Significant Slope
- Minor Street Relationship/Moderate Slope
- Streets including: Laurel Grove Avenue, Walters Road, Glenwood Avenue

BUILDING LEVEL CHARACTER DRIVERS

CONTEMPORARY HOUSE/ TRADITIONAL MATERIALS



Building Details

- Wall openings include traditionally proportioned windows that are regularly spaced
- Front wall is highly transparent
- Design includes a high level of detailing to create contrast and richness on the facade

Materials and Color Palette

- Exterior materials are wood and stone; color palette is natural or muted

Massing and Form

- Building mass is highly articulated with height variation and mass modulation
- Roof is a traditional pitched (sloped) form

TRADITIONAL HOUSE/ TRADITIONAL MATERIALS



Building Details

- Wall openings are regularly spaced and have traditional proportions
- Front wall is moderately transparent
- Building includes a high level of detailing and ornamentation

Materials and Color Palette

- Exterior materials are wood and clapboard siding; the color palette is natural or muted

Massing and Form

- Roof is a traditional pitched (slope) form

BUILDING LEVEL CHARACTER DRIVERS

CONTEMPORARY HOUSE/MIX OF TRADITIONAL AND NEW MATERIALS



Building Details

- Wall openings are irregularly spaced and have smaller proportions
- Front wall is minimally transparent
- Building includes a moderate level of detailing

Materials and Color Palette

- Exterior materials are a mix of synthetic and natural materials; the color palette is natural and subdued

Massing and Form

- Building mass is highly articulated with height variation and mass modulation
- Roof is a flat form

CONTEMPORARY HOUSE/ NEW MATERIALS



Building Details

- Wall openings are spaced asymmetrically and have taller proportions
- Building entry is oriented to the side of the building

Materials and Color Palette

- Exterior materials are synthetic stucco and clapboard

Massing and Form

- Building mass is moderately articulated with boxy modules
- Roof form is flat

Garage Design

- Garage is designed to match the primary house



Townwide Character Analysis

This section describes elements that contribute to Ross's physical character today. It focuses on features that occur in most parts of Town.

Informal Experience

There is an informal feel to one's experience in Ross. Varying topography, a mix of winding roads and gridded streets, along with a mix of informal sidewalks and walking streets create diversity in visual experiences for one on foot, on a bike or in a car. The rambling nature and variety of the landscape also adds to the Town's informal character. Within many neighborhoods, lot sizes, home sizes, building placement and building orientation vary considerably.



Diverse Architecture

While some attributes are shared among many buildings in Ross, such as the widespread use of natural materials, each building is different. Each design is unique. This is partially a result of the varying lot shapes and sizes, as well as the intent of individual designers and property owners.

Connection to Nature

A sense of contact with nature pervades throughout Ross. Terraced topography, rambling landscapes and meandering creeks are integral to the Ross experience. Most buildings fit harmoniously with environmental features in their siting, massing, use of materials and color palettes. Views to and from hillsides and distinctive geologic features also contribute to Ross's natural character.

Sense of Discovery

A sense of discovery exists along the Town's streets. The organic nature of the circulation system and the diversity of sites and architecture contribute to this quality. One's experience may change rapidly upon turning a corner or proceeding to another road. As one travels around a bend you may only glimpse a building that sits behind a heavily landscaped street edge. In another case, even when a home is highly visible, the design of a gate or a specimen tree provides a delightful surprise. The Town's historic bridges and creek crossings also contribute to this sense of discovery.

Lush and Varied Landscape

The lushness of Ross’s landscape is a character-defining element. This green, leafy environment is unforgettable. Some areas are informal with wooded hillsides or groves of redwoods. Others are more designed and maintained. Everywhere, the landscape is integrated with the architecture, and an element of greenness is ubiquitous. These features and the layering of them with one another contribute strongly to the Town’s character.

Diverse Topography

Varying topography is a critical driver of character. The mix of generally flat areas, with slightly sloping places and dramatically steep areas adds to the informal experience. An entire neighborhood may be defined by elevation changes, but this also occurs on individual properties. A building’s position at street grade, above or below the roadway also affects how it is perceived and how it contributes to the streetscape. This in turn impacts the Town’s character.

Small Town Scale

Ross exhibits a small town character. No wide arterials dominate the Town’s fabric. Streets range from two-lane streets to hillside roads. These narrow streets provide a close connection between private properties and the public way. Even Sir Francis Drake Boulevard is only a two-lane road. Buildings are generally of a modest scale overall, especially those visible from the street.

Walkable Experience

Ross is highly walkable. Narrow roadways slow traffic and the variety of streetscape experiences and the visual interest created by them are key factors. An ever-changing character is experienced where a roadway interfaces with private properties. Variety in landscapes, fences, street tree patterns, front yard designs, and architecture all contribute to this walkable experience.





Lot Coverage and Open Space

Substantial open space relative to the footprint of a building is a key feature. This is partially due to parcels that were shaped by topography and natural features, but is also an inherent design feature throughout the Town. In many of the hillside areas, building footprints occupy a small portion of the total lot area. In the flat, gridded areas of town, buildings often occupy a greater portion of the total lot area. In some cases, lot coverage may even exceed the Town's low lot coverage development standards. Regardless, landscaped open space is a common site design component.



Intermingling of Size, Scale and Lot Size

Building sizes vary, as do lot sizes. While small clusters of homes of a similar size and lot configuration exist, such as on Bolinas Avenue, lot characteristics vary widely across Town.

Detail and Craftsmanship

Many buildings demonstrate thoughtful detailing. From ornate to more simplistic styles, architectural detailing creates contrast, interest and a depth of shadow that provides a sense of scale. Window details, doors and siding and trim are prominent architectural features that express a sense of craftsmanship in Ross. This richness of detail is cherished.



Mix of Traditional and Contemporary Architecture

Many of Ross's buildings were designed decades ago and traditional architecture is abundant. Over the years, newer styles have joined these early homes. They represent a spirit of architectural innovation that is respectful of context. Traditional architecture is undoubtedly dominant, but the intermingling of newer designs adds diversity to community character. Newer interpretations of traditional forms are clearly distinguished, but they also utilize materials and detailing that integrate well with older neighbors. Some more modern forms with flat roofs and simple geometry also exist. This mixture of traditional and contemporary architecture is a notable characteristic of Ross.

Factors That May Influence the Importance of the Design Topics

Development varies considerably throughout the Town, along streets and even between neighboring properties. Because of this, individual design topics may be more important in some situations or settings, and less important in others. For example, an entry design may be less important for a house located above the road and substantially set back. Key factors that influence the importance of a design topic include:

Topography

In areas with steep terrain, buildings are often set back farther from the street and may not even be visible from the public realm. In these situations design topics such as building entry design, detailing and transparency may be less important to consider. Other topics such as street edge character, front yard design and connectivity to the street may be more important.



Street Configuration and Width

Street configuration and width may influence the importance of a design topic. On a narrow, winding street, building orientation and placement may not be an important topic to consider, because the curving streets and properties do not establish a strong pattern of setbacks or orientation. On a rectilinear street, setbacks and building orientation may be more important because there is more consistency from property to property.



Formality of Street Edge and Sidewalk Character

The formality of the street edge and the presence of a sidewalk may also impact the importance of a certain design topic. For example, when the street edge is informal, with vegetation and no sidewalk, it may be less important to consider connectivity from a building entry to the street. In other parts of Ross where the street edge has more formal landscaping and sidewalks, it may be more important to consider how a property connects to the street and how its front yard is designed.



Lot Size and Configuration

Lot sizes vary considerably throughout Ross. Where lot sizes are large and irregularly shaped, some design topics may be less important, including building placement, building orientation, entry design and porch design. In other areas where lots are small and regularly configured, these topics will be more important.



CHAPTER 3

OVERARCHING DESIGN PRINCIPLES



The design guidelines in this document seek to maintain the character of Ross while providing opportunities for new development and assuring the Town remains a desirable place to live. They promote maintaining traditional character, while encouraging creativity in design. The following overarching design principles provide the foundation for the design guidelines. Each project should help to achieve these principles. The Town will consider these principles when reviewing design proposals.

In This Chapter

Maintain the “Small-Town” Feel	24
Provide Excellence in Design	24
Contribute to the Landscape	24
Design in Harmony with Nature	24
Design Buildings to Fit the Community	24
Respect Neighboring Properties and Prioritize Privacy	25
Encourage Sustainable Development	25
Protect Important Views	26
Respect Heritage Resources	26
Promote Public and Personal Safety in Design	26



New development should reflect and enhance the existing small-town character of Ross.

Maintain the “Small-Town” Feel

New development should reflect and enhance the existing small-town character with low-density, appropriately-scaled design that represents diversity in design character. It should embrace and enhance Ross’s landscape, and should support a walkable, bikable community.



Thoughtful design should enhance the character of Ross, be sensitive to its surrounding context and create an enjoyable pedestrian-oriented experience.

Provide Excellence in Design

Each development in Ross should express excellence in design. This includes using high quality, sustainable materials; utilizing high quality construction methods; and paying attention to details.

Contribute to the Landscape

Ross is home to diverse landscapes and natural resources. Its tree canopy and signature “greenness” are key features of the town and should be maintained and enhanced to the extent feasible. New planting designs should use trees as a dominant landscape element, while addressing fire safety.

Design in Harmony with Nature

Ross’s buildings fit with the landscape, highlighting rolling hills and lush, varied street edges. New development should maintain this relationship by working with the natural environment, taking advantage of hillside features and avoiding excess cut and fill.



New infill development should maintain this relationship by working with the natural environment, taking advantage of hillside features and avoiding excess cut and fill on a site.

Design Buildings to Fit the Community

Ross’s residential environment is an eclectic mix of traditional and contemporary designs. New development should be sensitive to the existing built environment and the older buildings that represent Ross’s heritage. Individual buildings should not dominate the landscape.

Respect Neighboring Properties and Prioritize Privacy

In addition to designing new development to take cues from existing residential development, it should also respect the privacy of neighboring properties to the extent feasible. A variety of design options may be considered in order to achieve a design that respects the privacy of neighboring properties, including creating a natural, semi-transparent landscape buffer; strategically locating outdoor spaces to minimize their impact on neighboring properties; and carefully designing the mass and form of a new building to minimize looming effects.

The use of landscaping and plantings should also be considered for existing development as well as new development. When using landscaping, the design should not create solid, tall barriers along a property edge.

Encourage Sustainable Development

The Town of Ross promotes sustainability through policy and practice. Development proposals should promote sustainability in a variety of ways including reducing energy consumption, conserving resources, minimizing environmental impacts, incorporating low impact development principles to mitigate stormwater impacts and utilizing sustainable materials.



A variety of design options may be considered in order to achieve a design that respects the privacy of neighboring properties.

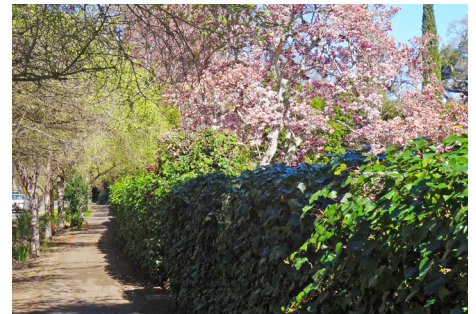

The use of landscaping and plantings should be considered for existing and new development.



Protect Important Views

The natural landscape and views of nearby hills are key features of the Town of Ross and should be preserved. As such, new development should respect and protect existing views from the public way to nearby natural features. Where appropriate, new development could also consider framing views through the strategic placement of buildings.

Ross has many view opportunities to nearby natural features. These should be protected. This principle does not discourage new development; instead, it promotes design in new development that thoughtfully considers the impact on views from the public way.



The hilly nature of much of Ross's residential areas creates many view opportunities to nearby natural features.

Respect Heritage Resources

While Ross does not have a local historic designation and preservation program, it possesses many buildings that are cherished by the community and potentially historic. This document refers to these types of buildings as 'heritage structures'. Maintaining these heritage structures is essential to preserving the Town's unique character that makes it so unique among other Marin County towns.

Heritage structures should be reused where possible in order to be kept an active part of the community, whether in their original use or in a new, appropriate use. An applicant proposing changes to a heritage structure must utilize a higher degree of sensitivity to the key features that convey the building's past. A development proposal near a heritage structure should consider a design that is compatible, recognizing important design variables such as setback, roof pitch and street presence.



Maintaining Ross's heritage structures is essential to preserving the Town's unique character, as they define a crucial part of the built environment.

Promote Public and Personal Safety in Design

Properties in Ross should be designed to reduce the potential for fire and flood damage. New structures should be located to minimize fire hazards. Building materials should be fire-resistant where appropriate and landscape designs should follow the established Wildland Urban Interface standards for those properties within the designated WUI zones. Flooding is also a hazard for some properties, and designs should consider how to minimize flood risk.

CHAPTER 4

SITE DESIGN GUIDELINES



Introduction

This chapter provides design guidelines for site design in Ross. Site design refers to the arrangement, placement and orientation of buildings and site features on a parcel. It also includes the relationship between buildings and site features on one parcel to neighboring properties and the public realm. Site design considerations include:

- Building placement
- Building orientation
- Secondary/accessory structure placement
- Street edge character/interface with the public realm
- Landscape design along street edge
- Front yard design
- Hardscape materials
- Pedestrian and vehicular connections
- Side yard relationships

In This Chapter

Introduction	27
Designing with Topography	28
Primary Building Placement	29
Primary Building Orientation	30
Secondary Structures and Accessory Dwelling Unit (ADU) Placement	31
Site Connections	38
Street Edge and Front Yard Design	41
Side Yard Relationship	54
Retaining Walls	55
Hardscape Materials	56
Site Lighting	57
Sustainability and Design	58
Low Impact Development (LID)	62



Step a fence with the natural topography of a site.

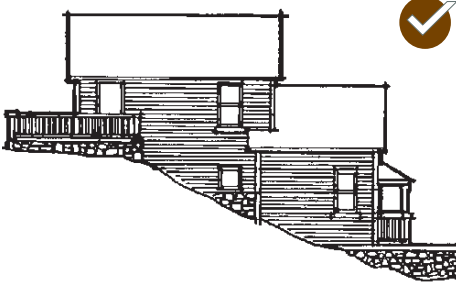

"Terrace" a building into a hillside to minimize the use of "cut and fill" and to create private outdoor spaces and site features.

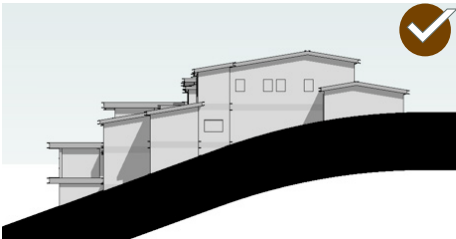

Design a building to respect and reflect the natural topography, especially in hilly areas.

Designing with Topography

Some projects occur on sites with steep topography and grade change. A site design should work with existing topography wherever possible rather than significantly altering natural slopes. This is a sustainable practice that helps to preserve terrain that contributes positively to Ross's character and it also helps to limit erosion. A regrading effort should not negatively impact the public realm.

4.1 Design a project to integrate with and take advantage of existing topography.

- Incorporate a topographic feature as an outdoor public space or landscape amenity where feasible.
- Where on-site parking is provided, consider taking advantage of site topography to provide subterranean or partially subterranean parking.
- "Terrace" a building into a hillside to minimize the use of "cut and fill" and to create private outdoor spaces and site features.
- Where grading is utilized, the design should retain water on site, enhance percolation into soils and minimize runoff onto adjacent properties.
- Step the first floor of a building along a sloped street to maintain a constant street presence.
- Where a taller cut or change in grade is necessary, use a series of landscaped terraces or stepped walls.
- Step a fence with the natural topography of a site.

4.2 Design a building to respect and reflect the natural topography, especially in a hilly area.

- Locate a building to preserve the natural slope.
- Design a building to be of a mass that reflects, respects and blends with site topography.
- Design a building in modules that follow the contours of the slope.
- Locate a building to minimize obstruction of views and site lines from surrounding properties, to the extent feasible.
- Utilize a roof pitch that is angled with the slope. Collectively, rooflines should reflect the naturally occurring ridgeline silhouette.
- Select colors and materials for new development that blend with the natural colors and hues of the surrounding hillsides.
- Utilize roof materials that are textured and of a darker tone such as brown, black and terracotta. Avoid bright or light-colored roofs.

Primary Building Placement

A building should be placed in a way that is considerate of its context. Where there is an established pattern of building setbacks, such as in the Constrained Grid Neighborhood context, a new building should be placed to align with the existing buildings. Where there is no established setback pattern, a building should be placed in a way that fits with the topography of the site. This is especially relevant in the Minor Street Relationship/Moderate Slope and Entry Element Street Relationship/Significant Slope contexts.

4.3 *Locate a building within the established range of setbacks on a block and orient it to the street when a visible connection is possible.*

- a. Where front yard setbacks are uniform, align a new building with neighboring structures.
 - * This is particularly important in the Constrained Grid Neighborhood and the Strong Street Relationship/Flat context.
- b. Locate a building to maintain the side yard spacing pattern along the street, where an established pattern exists. Correct existing non-conformities where possible.

4.4 *Locate a building to minimize disturbance to the natural topography.*

- a. On a site with a steep slope, locate the building to complement the topography.
 - * This is especially important in the Minor Street Relationship/Moderate Slope and Entry Element Street Relationship/Significant Slope contexts.

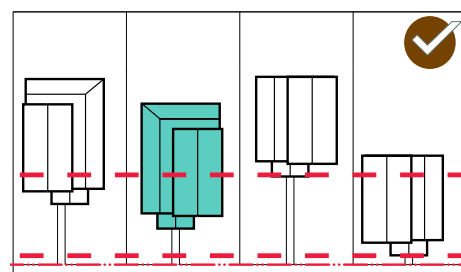
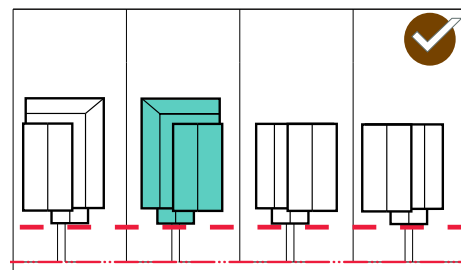

Locate a building within the established range of setbacks on a block. Some design contexts call for buildings that are set back uniformly with the existing context or within an established setback range (top diagram). In other contexts, more flexibility in building placement is appropriate (bottom diagram).



Where front yard setbacks are uniform, align a new building with neighboring structures.



Locate a building within the range of established setbacks on a block.



Where a building is visible from the street, locate the primary entrance on the front face of the building, or where it will be highly visible.

Primary Building Orientation

When a building is visible from the street, the primary entrance should orient to the street to create an engaging, pedestrian-friendly character. In many of Ross’s contexts, such as the Constrained Grid Neighborhood and Strong Street Relationship/Flat context, a porch helps make this connection. In other contexts, such as the Major Arterial Corridor and Minor Street Relationship/Moderate Slope, the relationship of the building to the street is not a character-defining feature. Therefore, more flexibility in building orientation should be allowed in these contexts.

- 4.5 *Orient a building to face the street, where this is an established component of the context’s character.*
 - a. Where a building is visible from the street, locate the primary entrance on the front wall of the building, or where it will be highly visible.
 - * This is especially important in the Constrained Grid Neighborhood and Strong Street Relationship/Flat contexts.

Figure 4.1: Example Building Orientations When Close To A Street

Depending on context, a range of building orientations may be appropriate for new development. The diagrams below illustrate a variety of building orientations, each of which may be appropriate, depending on context.

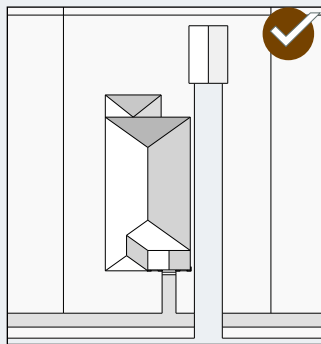

Building oriented toward and front wall parallel with the street.

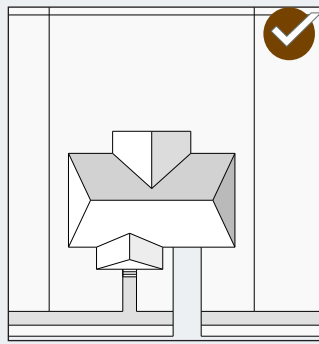

Building oriented toward and front wall parallel with the street.

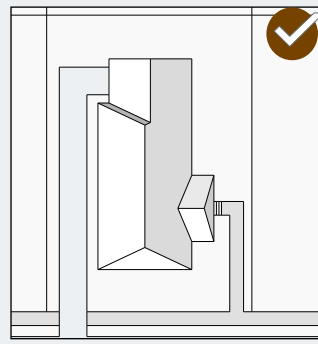

Front wall parallel to the street, with side entrance.

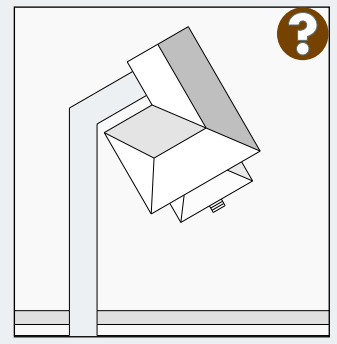

Front wall not parallel to the street. This orientation could be appropriate on a sloping site.

Secondary Structure and Accessory Dwelling Unit (ADU) Placement

A secondary structure, such as a garage, studio or shed, and any accessory dwelling unit (ADU) should be subordinate to the primary structure. It should be located to minimize the impacts of mass and scale on the primary structure and on adjacent properties.

- 4.6 *Minimize the visibility of a secondary structure or ADU.*
- a. Locate a secondary structure or ADU to the rear of a property, where feasible.
 - * This is especially important in context areas where there is a strong relationship between the building entry and the public realm, such as the Constrained Grid Neighborhood, Strong Street Relationship/Flat and Moderate Street Relationship/Flat and Mild Slope.
 - b. Locate a secondary structure behind the front wall of the primary structure when feasible.
 - c. Where a garage cannot be located to the rear of a property in one of the above context areas, minimize its visibility by orienting the garage perpendicular to the street.
 - d. Where a garage cannot be located to the rear of the property due to site constraints such as topography, design it to be visually appealing and to be part of the architectural style and design of the property.
 - * This is especially important in Minor Street Relationship/Moderate Slope and Entry Element Street Relationship/Significant Slope context areas.
 - e. Where an ADU cannot be placed to the rear of the property, locate it behind the rear of the front wall of the primary structure.
 - f. Where the established context includes secondary structures located forward of the front wall of the primary structure, orient the structure perpendicular to the street, where feasible, to minimize its appearance as a secondary structure.



Locate a secondary structure to be subordinate to the primary structure.



Where the secondary structure is visible from the street, orient the front wall of the structure to be parallel with the street.



Locate an Accessory Dwelling Unit (ADU) to be subordinate to the primary structure.

Refer to the Town's Municipal Code

Refer to Chapter 18.42 to learn more about parking requirements for Accessory Dwelling Units.

<https://www.townofross.org/administration/page/title-18-zoning>

Figure 4.2: Recommended Locations for Secondary Structures

The diagrams below illustrate recommended locations for a secondary structure. This table uses a garage as an example. The context and lot configuration are factors to consider. These scenarios show lots that are highly visible from the street. In some deep lot conditions or hillside settings, other options may be appropriate as well.

Detached Structure to the Rear of Primary Structure (Visible from the Street)

The secondary structure is located to the rear of the site and is visible from the street.

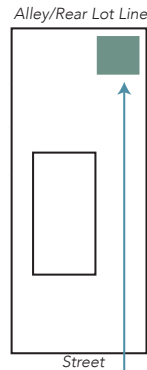

Detached Structure to the Rear of Primary Structure (Not Visible from the Street)

The secondary structure is located to the rear of the site, and placed fully behind the rear of the primary structure.

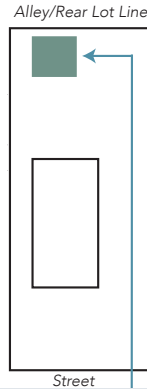

*Garage is seen from the alley in this photo.

Attached Structure to the Rear of Primary Structure (Not Visible from the Street)

The secondary structure is located to the rear of and attached to the primary structure. The secondary structure is not visible from the street, and is often oriented towards an alley.

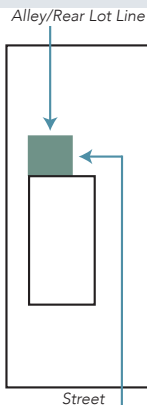

*Garage not visible from the street, but accessed via the driveway pictured.

Detached Structure at Rear of Primary Structure

The secondary structure is located to the rear of the primary structure and is visible from the street.

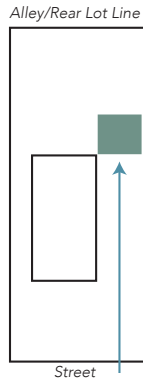

Attached Structure to the Side of Primary Structure

The secondary structure is attached to the primary structure and is set back from the front wall of the primary structure. The secondary structure may be one or two stories. Its design is consistent with the main house.

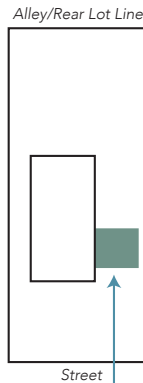

Incorporated Structure, Flush with Front Wall of Primary Structure

The secondary structure is slightly recessed from the front-most wall of the primary structure. This is appropriate for garages, not for other secondary structures.

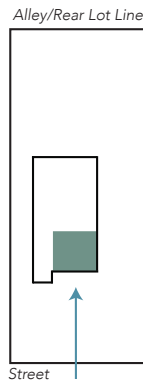

Attached Structure, Projecting from Front Wall of Primary Structure

The secondary structure is set completely in front of the front wall of the primary structure. This is appropriate for the placement of garages, not for other secondary structures. This is appropriate only in a small lot in a hillside setting where a front-loaded garage is the only option.

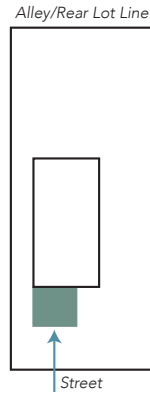

Attached Structure, Projecting from Front Wall of Primary Structure with Side Garage Entrance

The secondary structure is set completely in front of the front wall of the primary structure. The vehicular entrance to the garage is placed on the side of the garage structure. This is appropriate for the placement of garages, not for other secondary structures.

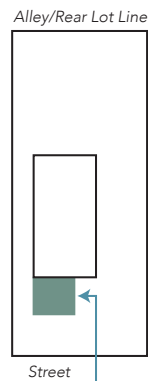
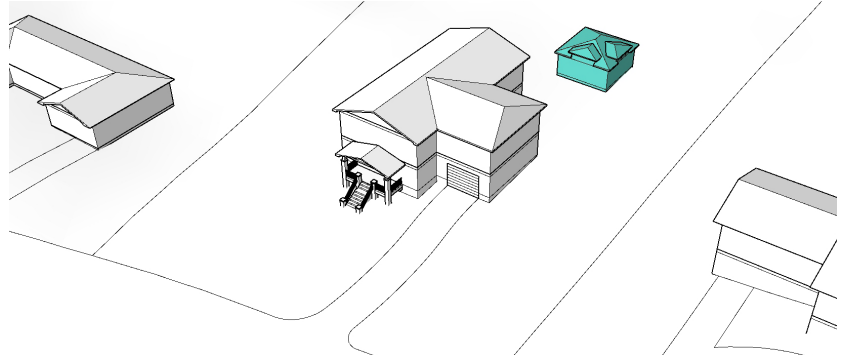

Figure 4.3: Recommended Locations for Accessory Dwelling Units (ADU)

The diagrams below illustrate the potential location of an ADU on a site.

One-Story Detached ADU at the Rear of Property

The ADU is located at the rear of the site, and placed behind the primary structure. The ADU is one-story.



Two-Story Detached ADU at the Rear of Property

The ADU is located at the rear of the site, and placed fully behind the primary structure. The ADU is two stories.

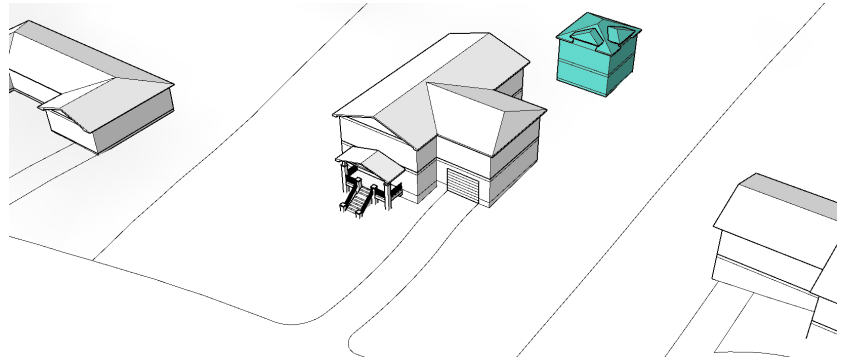

Two-Story Detached ADU at the Rear and Side of Property

The ADU is located at the rear of the site and to the side and fully behind the primary structure. It is visible from the street. The ADU is two stories and contains potential living space on the first and second floors.

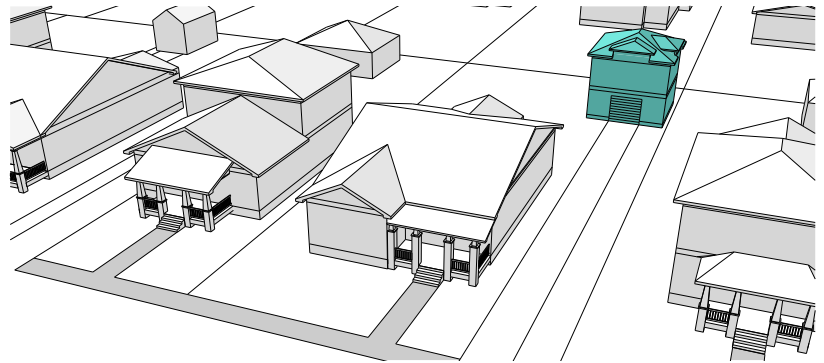

One-Story ADU Attached to the Rear of Building

The ADU is attached to the primary structure and is one-story in height.

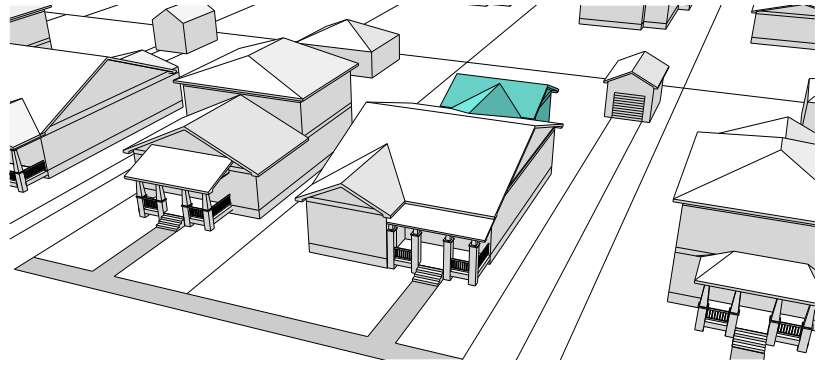

Garages and Off-Street Parking

Where a garage is visible from the public realm, it should be screened in order to be subordinate to the primary building. Where off-street parking is on a site, locating it to minimize its visibility is a key design consideration. Off-street parking spaces should be screened from the public realm using landscaping, fences or walls. See the sections on Street Edge and Landscape Design, and Fences and Buffers.

4.7 Screen a garage and off-street parking at the street edge with plantings, fences or walls.

- a. While plantings between 4' and 6' may be desired to minimize the visibility of cars on a site, they should be set back from the street edge to allow some permeability into the front yard.
 - * This is especially important for the Constrained Grid Neighborhood and the Strong Street Relationship/Flat contexts.
- b. Landscaping around garages and off-street parking also should comply with applicable Wildland Urban Interface standards.



Minimize the visibility of a garage on the site. Locate a garage to the rear of a property, where feasible.

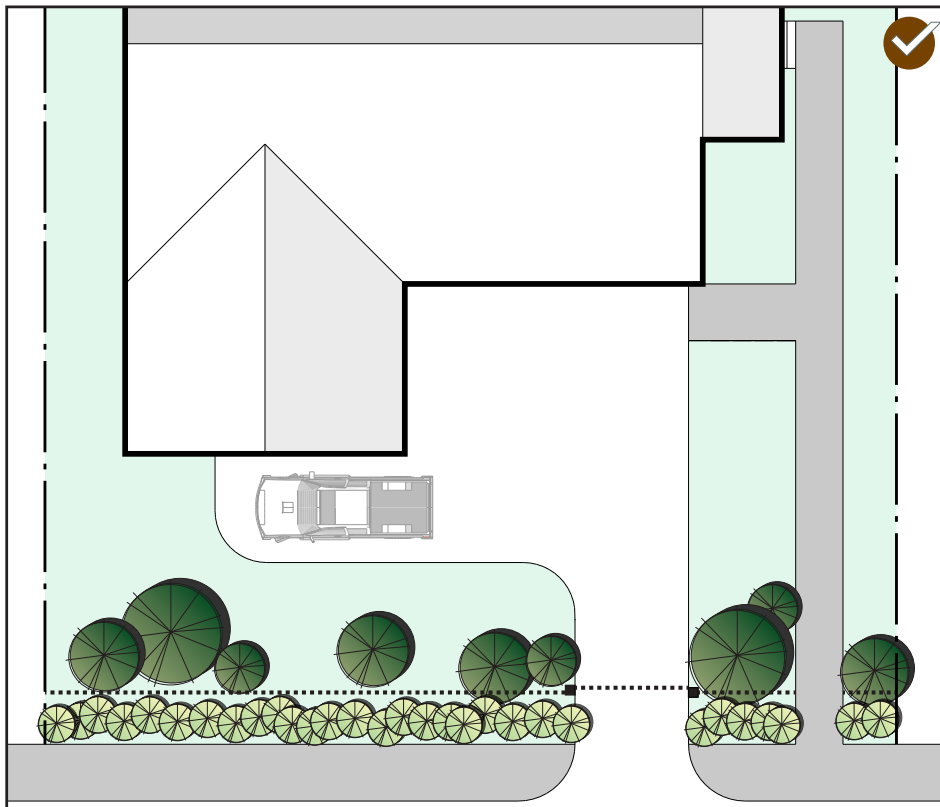

Off-street parking spaces should be screened from the public realm using landscaping, fences, walls or other strategies. In the diagram above, the car is located so it is less visible from the street; landscaping helps screen the parking area and driveway.



When a garage is visible from the street, design its facade to be a part of the architectural style of the property.



Choose a material for the driveway that is visibly distinguishable from the sidewalk in color, texture and/or style.



Distinguish the driveway entrance from the surrounding public right of way. Minimize the driveway width at the street.



Consider incorporating an accent material in order to define the driveway.

Site Connections

Vehicular and pedestrian connections are key to each Ross context in order to establish a visual and physical link. While not every connection will be visible from the public realm to the home, the connection should be distinguishable in the front property line.

Vehicular Connectivity

While a vehicular connection between a site and the public realm is essential to the functionality of the site, it should be visually subordinate to the landscaping along the street edge and to the building. The vehicular connection should also be distinguishable from the public sidewalk and the street to create a safe pedestrian-vehicular junction.

4.8 *Distinguish a driveway entrance from the surrounding public right of way.*

- a. Minimize the driveway width at the street. If a long driveway is needed on a site, increase the width of the driveway for parking as far back in the site as possible in order to minimize its visual impact.

*This is especially important for the Constrained Grid Neighborhood and Strong Street Relationship/Flat context areas.

4.9 *Select materials for the driveway and off-street parking that contribute to the overall site design.*

- a. Incorporate a material at the driveway entrance that is distinguishable from the street and sidewalk.
- b. Where a long driveway is needed on the site, consider incorporating a specific material to designate parking areas.
- c. Consider incorporating an accent material in order to define the driveway and parking areas. For instance, a driveway made of small concrete pavers with a brick or stone border distinguishes the driveway from surrounding landscaping.
- d. Refer to the Hardscape Materials guidelines for more details.

4.10 *Design off-street parking on the site to be a part of a coordinated site plan.*

- a. Consider the parking layout, parking area materials and screening when designing the front yard.
- b. Consider incorporating a carport or overhang adjacent to the garage to utilize an additional car space.

Vehicular Connectivity

In this scenario, the driveway tapers to minimize its width at the street. Paving material changes help distinguish the driveway entrance from the public realm and the parking area. The parking layout, parking area materials and landscape screening are designed to be part of the overall front yard composition.

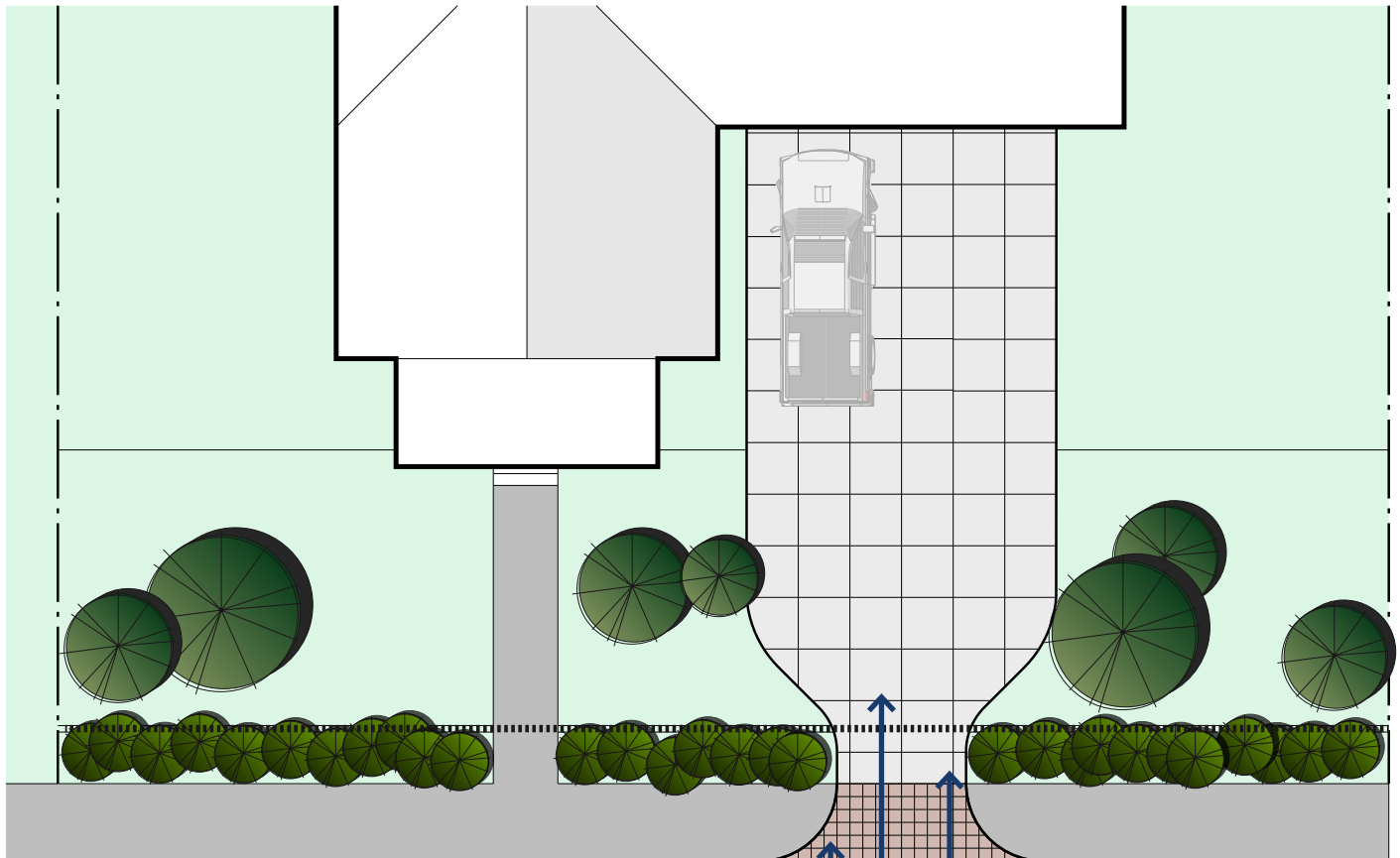

Creative solutions that provide emergency vehicle access while minimizing apparent width are especially appropriate.

Change in paving materials

Driveway width narrows at entrance (in conformance with Ross Valley Fire Dept. approval)

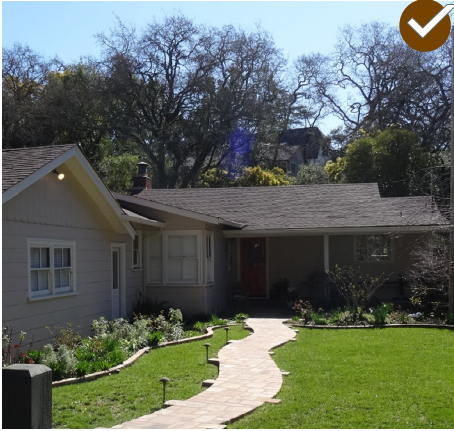

Provide a clearly visible pathway from a house to the street.

Pedestrian Connectivity to the Street

A pedestrian connection from a building to the street should be provided, where possible, to establish a visual and physical connection. In many Ross contexts, a path from the street or sidewalk leads to a front porch or stoop. However, in some Ross contexts, the site is not visible due to topography.

4.11 Provide a clearly visible pathway from a house to the street.

- a. Connect a path to the public sidewalk.
*This is particularly important in the Constrained Grid Neighborhood and Strong Street Relationship/Flat contexts.
- b. Distinguish a pathway to the entrance of the home by the use of distinct paving materials or site lighting.
*This is particularly important in the Constrained Grid Neighborhood and Strong Street Relationship/Flat contexts.
- c. Select hardscape materials that are compatible with those in areas of the site. Refer to the Hardscape Materials guidelines for more information.

4.12 Consider the use of a gate or an archway to highlight the connection of a pathway to the public realm.

- a. Refer to the Town Code Section 18.40.080(3) for more information about the requirements for single arbor-style entry elements in the front yard of a residential property.



Consider the use of a gate or an archway.

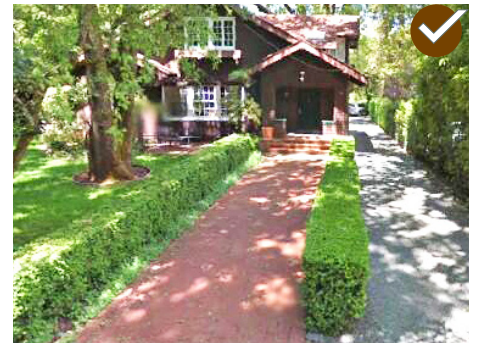

Provide a clearly visible pathway from a house to the street.

Street Edge and Front Yard Design

Well-landscaped front yards and street edges are key features that contribute to Ross's distinct character. This begins at the street edge and moves inward into the site in a series of landscape areas that result in a layering effect. This provides interest and a sense of connection with the street while also meeting functional requirements of privacy and security.

The street edge should be attractive for passersby. Landscaping along the street edge should complement the architecture and other site features and should also be compatible with the neighborhood context. For example, the Strong Street Relationship/Flat context exhibits low, manicured plantings at the street edge, whereas the Minor Street Relationship/Moderate Slope context sometimes includes taller plantings and topographical changes.

The typical landscape areas that combine for a layered effect are these:

Low Shrub Area

This incorporates low-scale plantings in the area closest to the street. Generally, plantings in the low shrub zone are between 0" and 18".

Fence and Wall Area

This lies immediately behind the Low Shrub Area. A fence or wall clearly defines the property edge while also permitting some views into the property.

Moderate Shrub Area

This lies behind the Fence or Wall Area. Landscaping in the Moderate Shrub Area includes a mix of medium scale shrubs and taller, flowering plants. These plantings generally range from 18" to 4' in height.

Front Garden Area

This area may include a variety of ground covers, shrubs and specimen trees that filter views to buildings beyond.

Foundation Area

Along the house and entryway is the foundation area. Where fire safety regulations permit, this may incorporate small trees and taller shrubs that transition into the entryway of the home. Generally, trees in this area are between 10' and 18' and shrubs may reach heights up to 6'. In fire safety zones, this area may be limited to non-pyrophoric material.

Typical Components of a Layered Landscape Effect

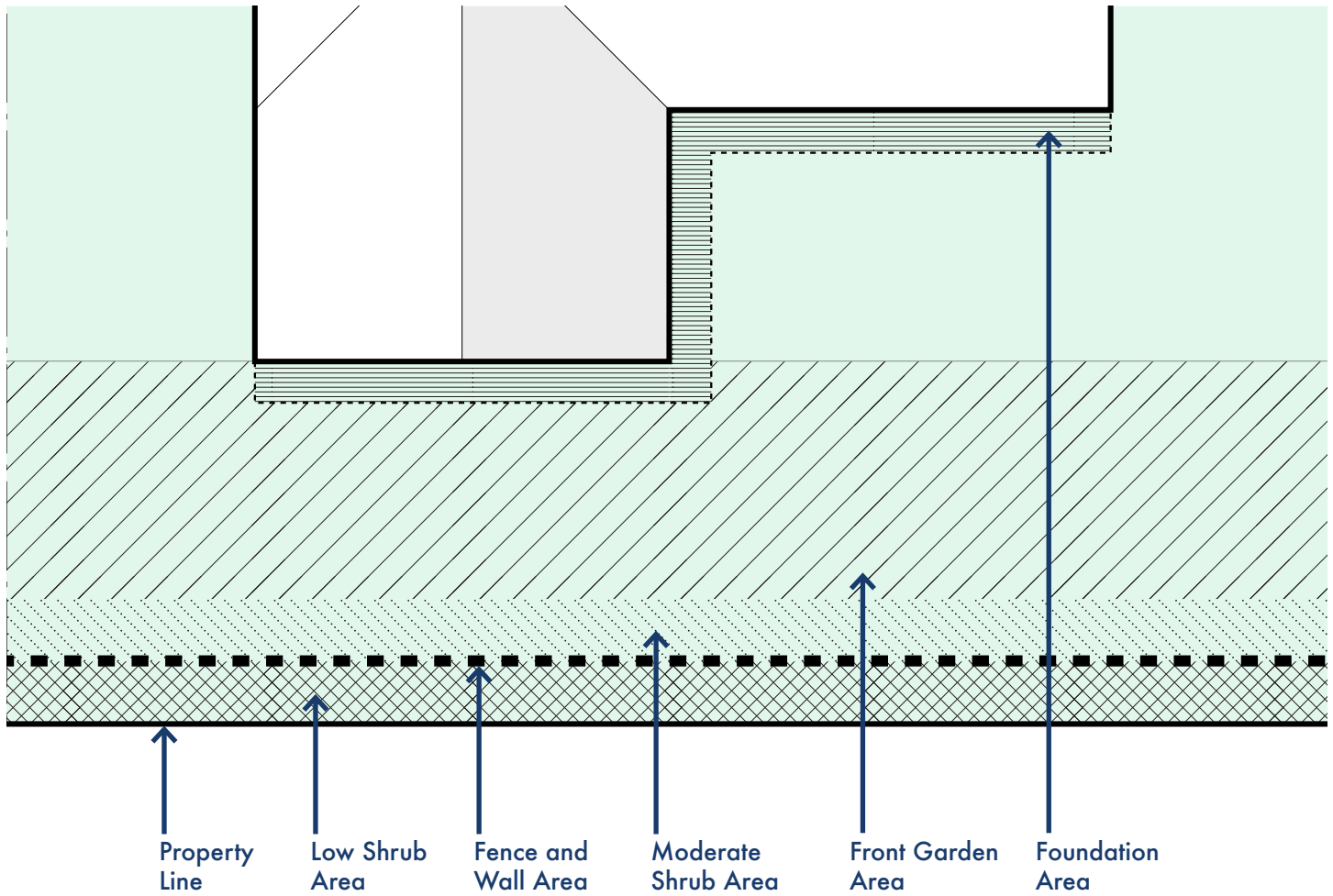

4.13 *Maintain a visual connection from the street into a property.*

- a. Incorporate low-scale plantings along a street edge to maintain views into the property.
 - * This is especially important for the Constrained Grid Neighborhood, Strong Street Relationship/Flat, and Moderate Street Relationship/Flat and Mild Slope contexts.
- b. Landscaping also should comply with applicable Wildland Urban Interface standards.



Incorporate low-scale plantings along a street edge to maintain views into to the property.

4.14 *Incorporate plantings along the length of the property line to create depth and visual interest.*

- a. Select plant materials that incorporate texture, color and depth.



Incorporate plantings along the length of the property line that create depth and visual interest.

4.15 *Protect existing street trees along a property line.*

4.16 *Layer the landscaping through the depth of the front yard.*

- a. Layering the landscaping is particularly important in contexts where the primary building is visible from the street. This includes the Constrained Grid Neighborhood and Strong Street Relationship/Flat contexts.
- b. See also the design guidelines that follow for fences, walls and hedges.



Incorporate low-scale plantings along a street edge to maintain views through to the property.



Where feasible and appropriate to the context, design the landscaping of a property to be layered. Landscaping should also comply with Wildland Urban Interface standards.



Layer the landscaping through the depth of the front yard.



Where a tall privacy fence or similar is desired, limit the solid portion and incorporate semi-permeable materials on the top portion of the fence.



Design a fence to complement the architectural style and character of the building.

Refer to the Town's Municipal Code

Refer to Chapter 18.40.080 to learn more about the permitted height of solid fences.

<https://www.townofross.org/administration/page/title-18-zoning>

Front Yard Fences

In many cases, a fence delineates the front of a residential property in Ross and is an important feature that enhances the street. While it may provide a degree of security and privacy, it also should promote a sense of connection with the neighborhood, by allowing some views into a property.

A fence also should be coordinated with other aspects of a property's site design and complement the character of the buildings on site. It should be of a scale that invites pedestrian activity along the street as well. For these reasons, its scale and materials are key considerations, along with the degree of visual permeability it has and its design relationship to other features on a property.

More flexibility in fence scale should be provided in situations where the front yard is adjacent to Sir Francis Drake Boulevard, as buffering from this major arterial may be more important than in other contexts.

Scale

4.17 *Vary design elements of a fence to enhance visual interest and provide a sense of scale. This is especially important for a long length of fence along a street edge. Use these techniques:*

- a. Change in materials
- b. Change in patterns and textures
- c. Change in the height of individual fence segments
- d. Change in the degree of transparency of individual fence segments
- e. Variance in the setbacks (offsets) of fence segments

Permeability

4.18 *Design a fence to permit some views into a property from the street.*

- a. For instance, include space between slats in a fence. This is particularly important for a tall fence. See the diagrams on page 46.

4.19 Minimize the potential barrier effect of a tall fence.

- a. A fence may exceed 4 feet if it permits some views into a property.
- b. A solid fence should be limited in height to permit views into a property.
- c. Where a tall fence is necessary, include a high degree of visual permeability in the top portion. For instance, where a 6-foot-tall fence is desired, the upper 18 inches should be a minimum of 50% visually permeable.
- d. Also use low plantings along the front to soften its appearance and reduce the perceived height.
- e. Generally, the taller a fence, the wider the planting bed in front should be. For instance, a 3'-4' planting bed in the low shrub zone is necessary for a fence over 4', while a narrower planting bed is appropriate for a shorter fence.



Relationship to the House Design

4.20 Design a fence to complement the architectural character of buildings on the site.

- a. Use material(s) that complement those of the buildings.
- b. Include design details that complement the character of buildings on site.

Fence Materials

4.21 Use materials that are durable in the Ross climate.

These materials are appropriate:

- a. Wood fencing
 - Wood fencing occurs in a variety of designs, including pickets, planks and cross-bracing.
 - A wood fence should have a painted finish in Constrained Grid Neighborhoods, in particular.
 - A wood fence may have an unpainted finish in Mild, Moderate and Significant Slope contexts.
- b. Metal fencing
 - Metal fencing may be considered, with these conditions:
 - » The open mesh should include 2"-4" open mesh.
 - » In hillside contexts should include 2"-8" open mesh.
 - Open wire fences should generally include plantings directly in front of or behind 50% of the fence's length.
 - Chain link is inappropriate, except in the Entry Element Street relationship/Significant Slope context area. Where chain link is used in this context area and is visible from the street, it should be screened with natural plantings.



Design a fence to complement the architectural style and character of the building.

Front Yard Fences

These illustrations show example designs that create a layered effect using fencing and plantings, while maintaining views to the property and creating visual interest. Note that fire safety regulations may influence how these may be applied in some locations.

4 ft. Tall Fence

- A** 4' Fence that is semi-permeable
- B** Low shrub area
- C** Hedge row in the moderate shrub area
 - Variety in hedge height allows views into property



Fence Above 4 ft. Tall

- A** 4' Fence with semi-permeable base with an 18" upper portion that is 50% permeable
 - *Fences taller than 4' are subject to Design Review
- B** Low shrub area
- C** Hedge row in the moderate shrub area
 - Variety in hedge height allows views into property



Long Fence Span & Articulation

- A** 4' Fence that is semi-permeable
- B** Low shrub area
- C** Fence sections are set back to allow for small tree planting and articulation for long fence spans to break up the perceived scale



Front Yard Walls

In some cases, a masonry wall delineates the front of a residential property in Ross and is an important feature that enhances the street. While it may provide a degree of security and privacy, it also should promote a sense of connection with the neighborhood, by allowing some views into a property.

A masonry wall also should be coordinated with other aspects of a property's site design and complement the character of the buildings on site. It should be of a scale that invites pedestrian activity along the street as well. For these reasons, its scale and materials are key considerations, along with the degree to which views into the property occur and its design relationship to other features on a property.

More flexibility in wall scale should be provided in situations where the front yard is adjacent to Sir Francis Drake Boulevard, as buffering from this major arterial may be more important than in other contexts.

Scale

4.22 Vary design elements of a masonry wall to enhance visual interest and provide a sense of scale. This is especially important for a long length of wall along a street edge. Use these techniques:

- a. Change in materials
- b. Change in patterns and textures
- c. Change in the height of individual wall segments
- d. Change in the degree of transparency of upper portions of the wall
- e. Variance in the setbacks (offsets) of wall segments

Permeability

4.23 Design a masonry wall to permit some views into a property from the street.

- a. A low wall is preferred, to permit views into a property. See the diagram on the next page.

4.24 Minimize the potential barrier effect of a tall wall.

- a. A masonry wall may exceed 4 feet if it permits some views into a property.
- b. A solid wall should be limited in height to permit views into a property.
- c. Where a tall wall is necessary, include a high degree of visual permeability in the top portion. For instance, use a low masonry base and install a more transparent fence segment on top of it.
- d. Also use low plantings along the front to soften the appearance and reduce the perceived height.
- e. Generally, the taller a wall, the wider the planting bed in front should be. For instance, a 3'-4' planting bed in the low shrub zone is necessary for a fence over 4', while a narrower planting bed is appropriate for a shorter wall.

Relationship to the House Design

4.25 Design a wall to complement the architectural character of buildings on the site.

- a. Use material(s) that complement those of the buildings.

Wall Materials

4.26 Use materials that provide a sense of scale and convey visual interest. These materials are appropriate for the face of a wall:

- a. Stone is preferred.
- b. Stucco may be considered, if it is compatible with the architecture on site.
- c. Exposed, untextured concrete or concrete block may be considered subject to design review.

Front Yard Walls

This illustration shows a design that creates a layered effect using walls and planting, while maintaining views to the property and creating visual interest.

Wall Above 4 ft. Tall

- A** 6' Wall with solid base (4' max) and top 18" that is 50% permeable
 - *Walls taller than 4' are subject to Design Review
- B** Low shrub area

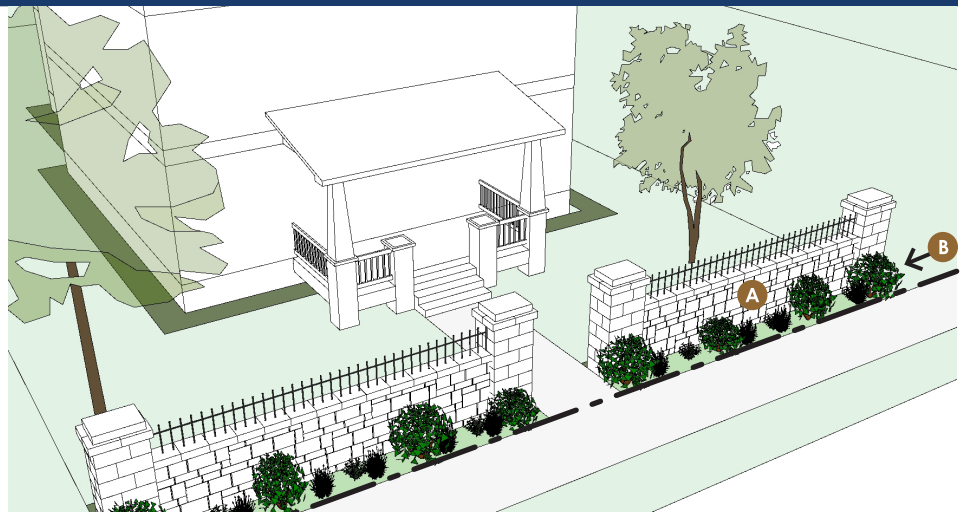

Front Yard Hedges

In some cases, a hedge delineates the front of a residential property in Ross and is an important feature that enhances the street. While it may provide a degree of security and privacy, it also should promote a sense of connection with the neighborhood, by allowing some views into a property. Its scale and the degree to which views into the property occur are important considerations.

More flexibility in hedge scale should be provided in situations where the front yard is adjacent to Sir Francis Drake Boulevard, as buffering from this major arterial may be more important than in other contexts.



Design a hedge to permit some views into a property from the street.

Scale

4.27 *Vary massing of hedge plantings to enhance visual interest and provide a sense of scale. This is especially important for a long length of hedge along a street edge. Use these techniques:*

- a. Change in plant materials
- b. Change in the height of individual hedge plants
- c. Variance in the setbacks (offsets) of hedge segments

Permeability

4.28 *Design a hedge to permit some views into a property from the street.*

- a. A low hedge is preferred, to permit views into a property. See the diagram on the next page.

4.29 *Minimize the potential barrier effect of a tall hedge.*

- a. Where a hedge is desired as part of the planting strategy along the front edge of the property line, design and locate the edge to maintain visibility into the property and to create visual interest at the property edge.
- b. Plant a hedge in front of or behind an existing fence or wall, at a height that is no greater than 6'.
- c. Where a hedge is not adjacent to a fence or wall, limit its height to 4' along the property line.
 - A hedge may exceed 4 feet if it permits some views into a property.
- d. A solid massing of hedge plants should be limited in height to permit views into a property.
- e. Where a tall hedge is necessary, include a high degree of visual permeability by spacing individual plants or vary the height of hedge plants.
- f. Also use low plantings along the front to soften its appearance and reduce the perceived height.
- g. Generally, the taller a hedge, the wider the planting bed in front should be. For instance, a 3'-4' planting bed in the low shrub zone is necessary for a hedge over 4', while a narrower planting bed is appropriate for a shorter hedge.

Front Yard Hedges

This illustration shows an example design that creates a layered effect using hedges and other plantings, while maintaining views to the property and creating visual interest.

Hedge at Property Line

- A** Hedge row in the moderate shrub area with a maximum height of 6'.
 - Variety in the hedge height allows views into property
- B** Low shrub area



Locate the vehicular gate in alignment with the fence or wall to maintain its visual definition of the property.

Front Yard Gates

Gates which are carefully crafted and integrated with street front landscaping are distinctive features that contribute to the character of Ross. These occur as vehicular and pedestrian gates which lead from the street into properties. Each gate should be designed to complement the scale, style and materials of a fence, wall or other landscape features placed along the street edge. It should also allow some views into a property. See also the Town's Municipal Code for more standards for gates.

More flexibility in gate scale should be provided in situations where the front yard is adjacent to Sir Francis Drake Boulevard, as buffering from this major arterial may be more important than in other contexts.

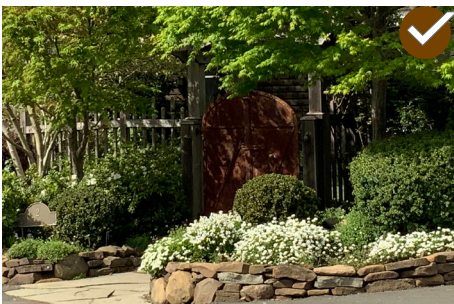

Design a pedestrian gate to be compatible with the fence or wall.

4.30 Design a gate to be a continuation of and complement to street edge landscaping.

- a. Coordinate the gate with the style, scale and materials of the street edge, as well as the architecture of the home.

- 4.31 *Locate a pedestrian gate to maintain the design relationship with the fence or wall, and to maintain the visual connection into the property.*
- a. When locating a pedestrian gate on the property line, limit its height to 4'.
 - b. Where a pedestrian gate is set back from the property line, it may be taller than 4', but must incorporate landscaping around the edges of its base and must be no more than 50% opaque on the top 18" of the gate.

4.32 *Design a pedestrian gate to be compatible with the fence or wall.*

4.33 *Incorporate a vehicular gate that is compatible with the fence or wall.*

- a. Locate the vehicular gate in alignment with the fence or wall to maintain its visual definition of the property.
- b. Design a vehicular gate to be low in scale (typically around 3') to maintain the visual connection between the public and private realms.
- c. Where a tall vehicular gate is desired, it may not be solid above 4'. The top 18" of a vehicular gate that exceeds 4' must be no more than 50% opaque to maintain the visual connection into the property.

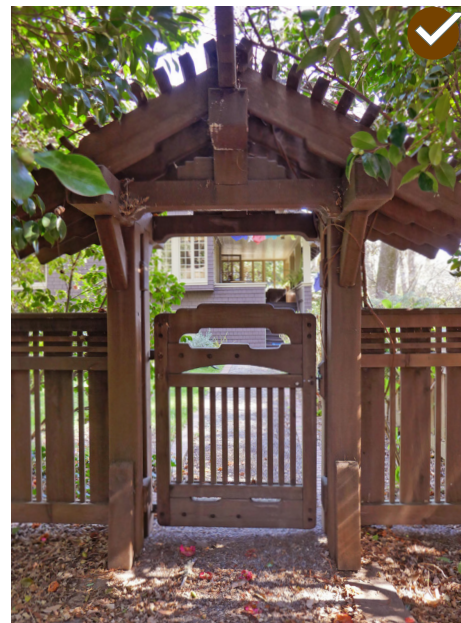

Design a pedestrian gate to be compatible with the fence or wall.



Design the vehicular gate to be low in scale to maintain the visual connection between the public and private realms.



Design a pedestrian gate to be compatible with the fence or wall.

Refer to the Town's Municipal Code

Refer to Chapter 18.40.080 to learn more about regulations for gates.

<https://www.townofross.org/administration/page/title-18-zoning>



Utilize landscaping materials that minimize the need for irrigation.

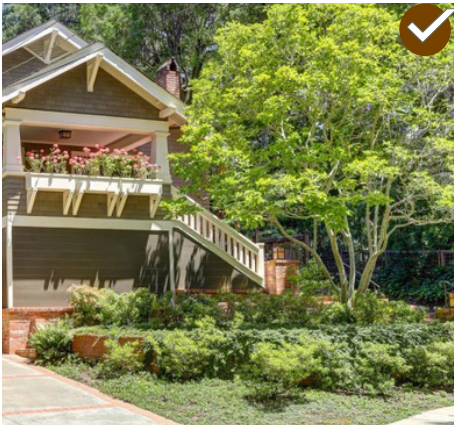

Creative solutions that maintain a sense of traditional front yards are encouraged.

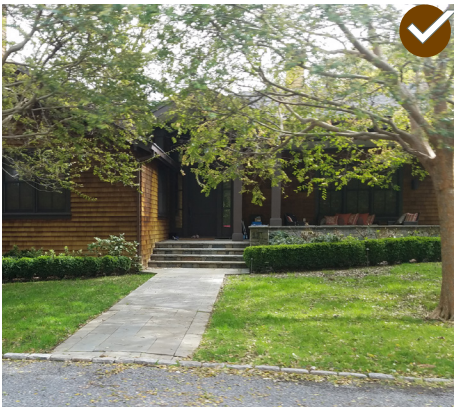

Maintain visibility from the street to the house.

Front Yard Design

A landscaped front yard is an important feature in neighborhoods throughout Ross. The front yard separates a home from the public realm and provides a sense of entry to the property. It also adds visual interest along the street. A front yard should be designed to complement the architecture and the site, and incorporate natural plantings, and minimize hardscape and surface runoff. Front yards incorporate a range of materials including small trees and low plantings. The front yard character and plantings vary based on context area. The majority of the guidelines that follow focus on front yards that are highly visible from the street. On properties located in a Wildland Urban Interface zone, landscaping should be designed in accordance with Wildland Urban Interface standards, which may affect how some of these guidelines apply.

4.34 *Maintain a landscaped front yard.*

- a. Creative solutions that convey a sense of traditional front yards are encouraged.
- b. Maintain visibility from the street to the house.
 - * While this is crucial for context areas including the Constrained Grid Neighborhood and the Strong Street Relationship/Flat, it may be more difficult for context areas such as the Entry Element Street Relationship/Significant Slope.
- c. Utilize plantings that minimize the need for irrigation.
- d. Minimize the amount of hard surface in a front yard, to the extent feasible. Where a hard surface is needed, incorporate permeable paving techniques such as open-joint paving.

4.35 *Incorporate plantings that create a layered look from the street to the home to create a sense of entry to the building.*

- a. Consider incorporating low-scale trees (generally 12'-25' in height) that screen a home from the street and frame views, but that do not fully obscure a home from the street.
- b. Include foundation-scale plantings that provide a transition between the front yard and the home, where fire safety considerations permit.

4.36 Within the foundation area, incorporate plantings that visually connect a house to its site.

- Utilize plants ranging from 30"-42" in height. However, where the entry or porch is raised, incorporate plants that match the height of the floor level of the porch.
- Foundation planting should also comply with the Wildland Urban Interface standards when they are applicable.



4.37 Where a property is located within a Wildland Urban Interface zone, follow the Fire District standards for tree and plant selection and placement.

Consider incorporating low-scale trees (generally 12'-25' in height) that screen a home from the street and frame views, but that do not fully obscure a home from the street.

4.38 Provide visual interest along Sir Francis Drake Boulevard.

- A taller privacy wall or fence may be appropriate to buffer the street from home.
- Utilize plantings along the street to create visual interest and minimize the visual impact of a privacy wall or fence.
- Design a privacy wall or fence to include articulation, such as:
 - Change in materials
 - Change in patterns and textures
 - Change in the height of individual segments
 - Change in the degree of transparency of upper portions of the wall or fence
 - Variance in the setbacks (offsets) of individual segments



Within the foundation area, incorporate plantings that visually connect a house to its site.

Tree Option 1

In this scenario, the garden area has a medium size tree in the center, along with the other planting elements. This scenario illustrates an appropriate, medium density front garden area.

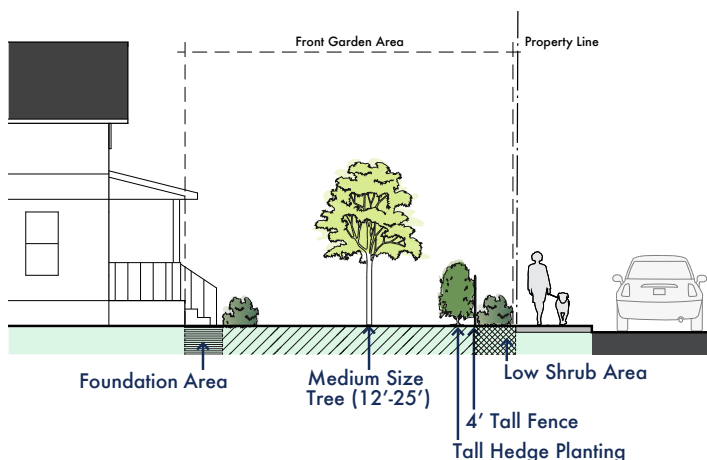

Tree Option 2

In this scenario, the garden area has a large shade tree near the property line and a small tree near the structure, along with the other planting elements. This scenario illustrates an appropriate, medium density front garden area.

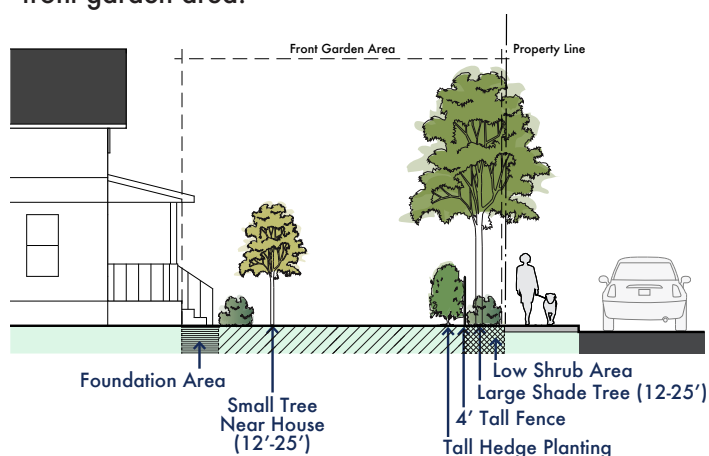



Side Yard Relationship

In addition to the importance of designing a site to be visually appealing from the street, the design should also consider the relationship with adjacent properties. While some form of separation between sites is appropriate, a solid, tall buffer that isolates one site from another is inappropriate. It also should not block views, light or air, or create unnecessary shadow on a neighboring property, to the extent feasible.

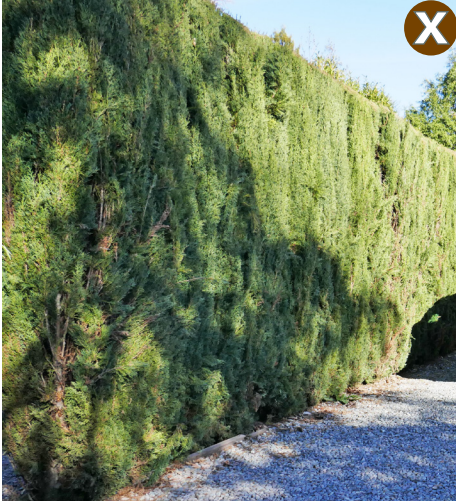

Avoid creating an opaque buffer that obscures all views between properties by limiting the height of the buffer to 6' and/or using a material(s) that is partially transparent.

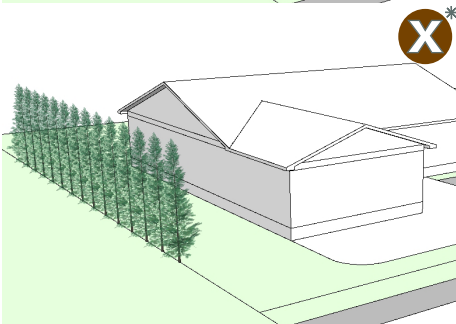
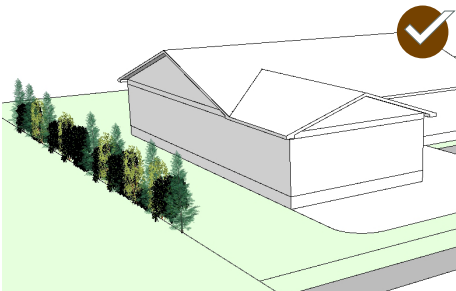

Where a fence, wall or natural buffer is used along a long property line, visually articulate the buffer in order to avoid a uniform appearance. *The bottom example may be appropriate in some contexts.

4.39 Incorporate a planted buffer, fence or wall between properties to provide privacy.

- a. Avoid creating an impermeable buffer that obscures all views between properties by limiting the height of the buffer to 6' and/or using a material(s) that is partially transparent.
 - * This is especially important for properties in the Constrained Grid Neighborhood, Strong Street Relationship/Flat and Moderate Street Relationship/Flat and Mild Slope contexts where lots are smaller and homes are closer to one another.
 - * On larger lots with greater distances between homes, incorporating a buffer that is up to 12' in height may be considered.

4.40 Consider the existing access to views, light and air neighboring properties have when adding or incorporating tall trees or plantings, or building a new structure on a site.

4.41 Minimize the amount of shadow created on neighboring properties.



Incorporate a planted buffer, fence or wall between properties to provide privacy.

Retaining Walls

Retaining walls are common features in Ross. The visual impact of a retaining wall should be minimized. It should appear low in scale and blend with the natural environment. This may include stepping the height of the retaining wall to follow the topography, and using materials and textures that blend with the setting.

4.42 Step a retaining wall to follow the natural topography.

- a. Retaining walls must also comply with the dimension requirements in the Town's Municipal Code.

4.43 Articulate a retaining wall to break up its perceived scale.

4.44 Design and detail a retaining wall to provide visual interest.

- a. Appropriate methods include:
 - Using natural stone
 - Scoring/texturing concrete walls
 - Using a finish technique such as acid-etch, water-wash, sandblasting or board form.
 - Using landscape screening (vines or other vegetation)
- b. Avoid smooth trowel finish and untreated plywood form finish.
- c. CMU blocks are discouraged.

4.45 The material of retaining walls should relate to, and be compatible with, those of other site features.

Refer to the Town's Municipal Code

Refer to Chapter 18.39.090 to learn more about retaining walls.

https://www.townofross.org/sites/default/files/fileattachments/administration/page/249/18.39_hillside_lot_regulations.pdf

Retaining Walls & Creek Edge Stabilization

In some cases a site may include steep topography that is adjacent to a stream or waterway. Bank stabilization may help reduce erosion and grade disturbance. For more information, please see:

<https://www.usbr.gov/tsc/techreferences/mands/mands-pdfs/A-BankStab-final6-25-2015.pdf>



Design and detail a retaining wall to provide visual interest.



Highlight a change in paving texture to define a walkway, on-site parking or a driveway.



Where a hard surface is needed, incorporate porous paving materials that retain water on site.



Where a hard surface is needed, incorporate permeable paving techniques.

Hardscape Materials

While the use of significant amounts of hardscape materials is discouraged in a front yard, these are often needed to define a specific component of the landscape design. Hardscape materials can provide visual interest and should complement the architecture and overall site design. Whenever possible, using permeable/porous hardscape materials is highly encouraged. Refer to the Town Code Section 18.41.100 to learn more about requirements for drainage and impervious surfaces.

4.46 *Minimize the amount of hardscape materials used in a front yard.*

4.47 *Where a hard surface is needed, incorporate permeable techniques such as open-joint paving.*

4.48 *Strategically utilize hardscape materials to highlight components of the landscape design. For instance:*

- Highlight a change in paving texture to define a walkway, on-site parking or a driveway.

4.49 *On smaller lots, design the hardscaped sections as a uniform composition.*

* This is particularly important for contexts that have a driveway, entry path and parking area that are visible from the street, such as the Constrained Grid Neighborhood and Strong Street Relationship/Flat contexts.

4.50 *Select hardscape materials that complement the architecture and site. Examples include:*

- Concrete with a weathered appearance. Appropriate finishes include natural water-wash, acid-etch, sandblast and surface retarder. This material is especially appropriate in creating “Hollywood” or “tire track” driveways with a planted center strip, and “step stone” driveways with concrete panels.
- Gravel
- Chip seal (gravel with asphalt binder)
- Decomposed granite with stabilizer
- Sand-set or mortared brick that is compatible with the building in color and style
- Precast concrete pavers or stone pavers that are compatible with the building in color and style
- Interlocking concrete pavers (rectilinear patterns are preferred)
- Cellular grassed paving
- Turf reinforcement systems
- Avoid the use of stamped concrete.

Site Lighting

Site lighting enhances a property and provides for safety. It should be designed to minimize light pollution, and should be coordinated with the site design.

- 4.51** *Incorporate site lighting only where it is needed.*
- Avoid lighting the entire property.
 - Provide lighting at address signage and at a pedestrian entry.
 - Light the path of travel for nighttime pedestrian safety.
- 4.52** *Scale site lighting to its purpose.*
- Use small scale fixtures with down-lighting to illuminate pedestrian walkways, whenever possible.
- 4.53** *Shield site lighting to minimize off-site glare onto adjacent properties and toward the sky.*
- Orient a fixture downward.
 - Incorporate a cut-off shield to direct light downward.
 - Utilize dimmers, timers and motion sensors to ensure lighting is only activated when needed.
 - Limited usage of uplighting may be appropriate if it does not adversely affect neighboring properties and does not contribute to light pollution.
- 4.54** *Select lamps with warmer colors.*
- 4.55** *Install a lamp that is energy efficient.*

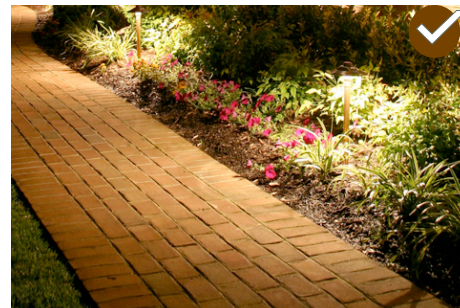

Use small scale fixtures with down-lighting to illuminate pedestrian walkways, whenever possible.



Shield site lighting to minimize off-site glare onto adjacent properties and toward the sky.

International Dark Sky Criteria

Information on the criteria for meeting the International Dark Sky Association's standards can be viewed using the following link:

<https://www.darksky.org/our-work/lighting/>

Refer to the Town's Municipal Code

Refer to Chapter 18.40.190 to learn more about the lighting.

<https://www.townofross.org/administration/page/title-18-zoning>



Incorporate stormwater management systems that minimize runoff and maximize water quality.

Sustainability and Design

Properties should incorporate sustainable design features to reduce environmental impacts, to reduce stormwater runoff, and to conserve water and energy. When designing a site, sustainability practices should be incorporated.

- 4.56 *Incorporate drought tolerant plant materials in a site design.*
- 4.57 *Select materials that reduce energy consumption.*
- 4.58 *Incorporate landscaping to reduce the need for heating and cooling.*
 - a. Use trees and landscaping to create shade in warm months and sun exposure in cool months.

Fire Safety in Landscape Design

Following Fire District guidelines also is required for properties within a Wildland Urban Interface zone, and all properties are required to use Wildland Urban Interface compliant materials per 337 of the Residential Building Code. The guidelines in this section offer best practices for all properties in Ross, not only those inside Wildland Urban Interface zones.

4.59 *Where a property is within a Wildland Urban Interface zone, follow the Fire District guidelines.*

4.60 *Where permitted, consider these best practices to reduce fire risk and maintain a sustainable site design:*

- Keep ornamental gardens and plantings irrigated.
- Remove pyrophytic plants and flammable materials from the site.
- Incorporate fire-resistant plants where feasible.
- Prune trees to eliminate dead wood and branches over chimneys and roofs.

Basic Fire Safety Tips for All Properties

- Provide an irrigated landscape for the first 30' around a structure.
- Avoid using pyrophytic (fire-prone) plants.
- Remove existing pyrophytic plants, including trees.
- Remove dead wood from tree canopies that overhang roofs and chimneys.
- Prune back or thin tree canopies that overhang roofs and chimneys, where feasible.
- Remove underbrush and flammable debris.
- Consider using fire-resistant materials for exterior site features such as gates, fences and walls.

Wildland Urban Interface Standards

Information on the criteria for meeting the Wildland Urban Interface Standards can be viewed using the following link:

<http://www.rossvalleyfire.org/prevention/standards>

Planning a Landscape For Fire Safety

This illustration provides suggestions that may improve fire safety while enhancing Ross's traditions as a green community. Note that other regulations related to WUI may influence how these ideas are applied.

- A** Trees spaced and understory managed to reduce fire spread
- B** Scattered low-scale deciduous and fire-resistant trees in the front garden area
- C** Low-scale deciduous and fire-resistant plantings set away from the building foundation
- D** Site features use non-combustible materials
- E** Clustered groups of plantings at front property line, not a continuous row

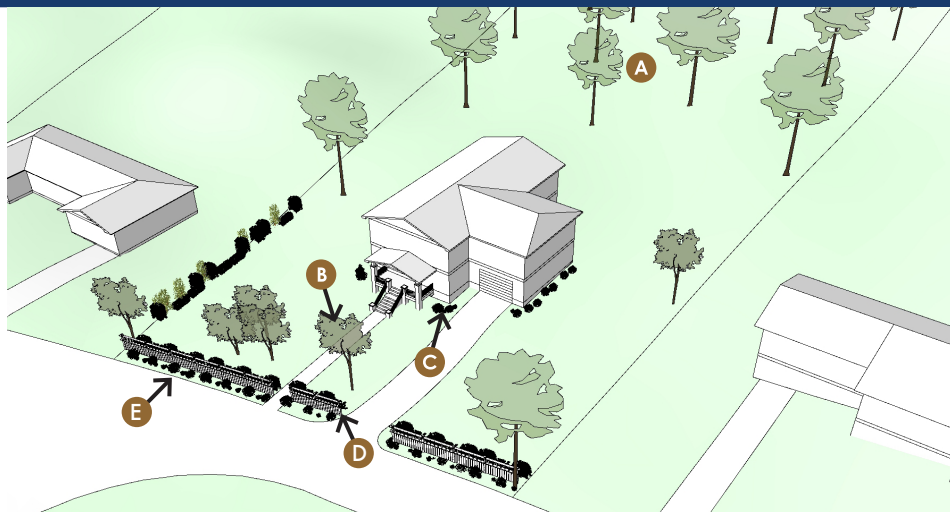

FEMA Flood Maps

Use the following link to determine whether your property is within the FEMA flood zone. If so, other regulations apply.

http://www.marinmap.org/Html5Viewer/?viewer=fema_lomc_h5&run=AutoSuggestAddress

Flood Damage Prevention

The Town of Ross Flood Damage Prevention ordinance provides guidance for minimizing private and public losses due to flood conditions:

https://www.townofross.org/sites/default/files/fileattachments/administration/page/247/15.36_flood_damage_prevention.pdf

Design of Raised Buildings

In some cases, it may be desirable or necessary to elevate the foundation of an existing building or new residential structure to provide greater flood protection. An elevated foundation should be compatible with the overall design of the residential building and the character of Ross.

4.61 When raising a structure, maintain the overall proportions of the facade.

- Provide detailing to articulate the wall of a raised foundation and to break up its perceived scale.
- Screen a raised foundation with landscaping elements such as planters. (Such landscaping elements may also be set away from the foundation to create a visual screen while complying with WUI standards).

4.62 Minimize the visual impact of any stair extension.

- Consider breaking up a stair extension to keep its proportions similar to the original scale.
- If the facade is symmetrical in composition, then the stair extension should also be symmetrical.

Example Stair Extension Design

Depending on context, a range of options may be appropriate for designing a stair extension. The diagrams below illustrate a variety of options, each of which may be appropriate, depending on context.

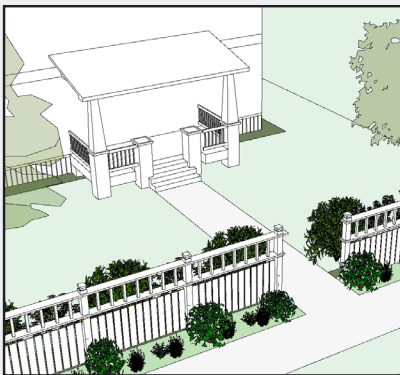

Existing condition (normal foundation height).

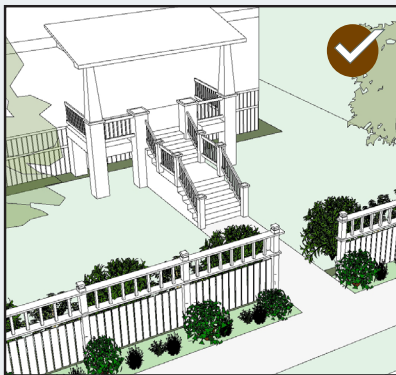

This stair extension accommodates the raised foundation with a landing that breaks up the length of the stairway, while maintaining the symmetry of the facade.

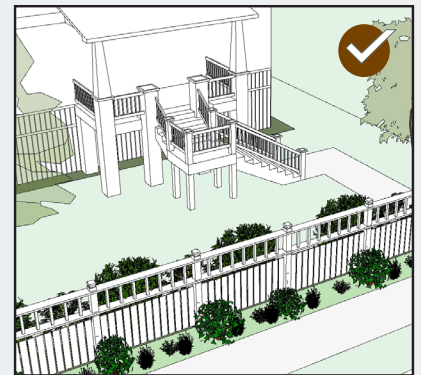

This stair extension accommodates the raised foundation with a right turn that allows the stair to function without encroaching on the front property line. While it is asymmetrical, it is compatible with the traditional proportions of the facade.

Example Foundation Treatments for Raised Buildings

Depending on context, a range of options may be appropriate for the treatment of a raised foundation. The intent is to reduce the perceived increase in height of the foundation. The diagrams below illustrate a variety of options, each of which may be appropriate, depending on context.

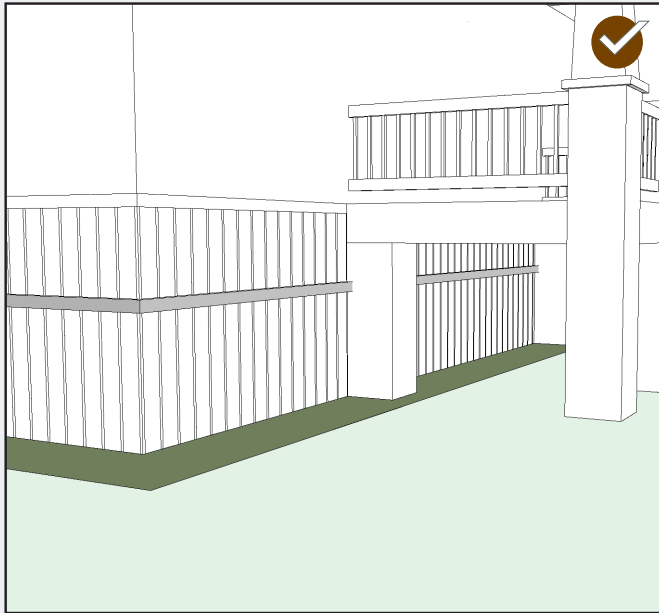

A horizontal belt course reduces the perceived height of the raised foundation.

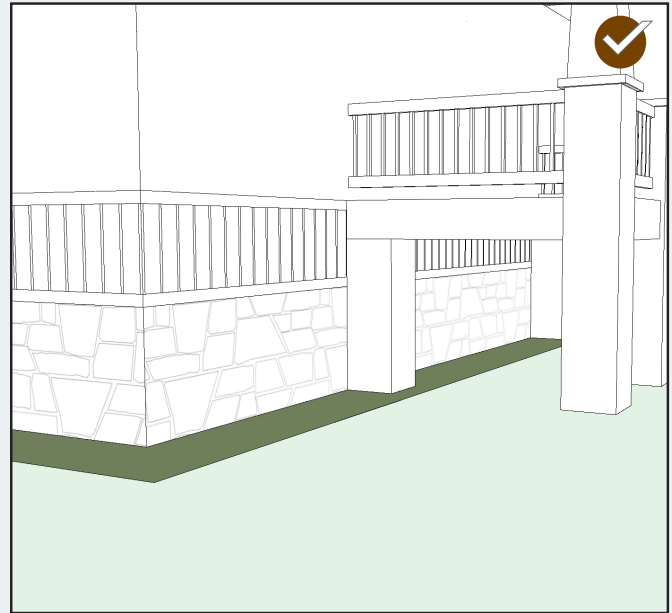

Masonry creates detail on a raised foundation to break up the perceived scale.

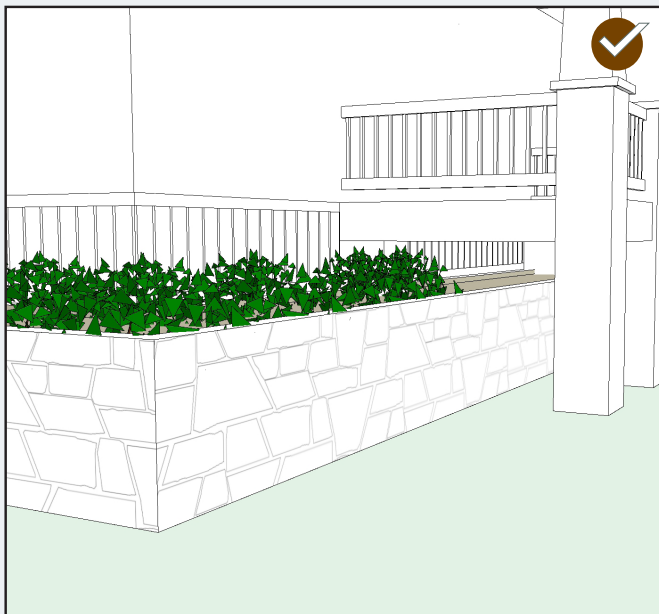

A planter screens the raised portion of the foundation.

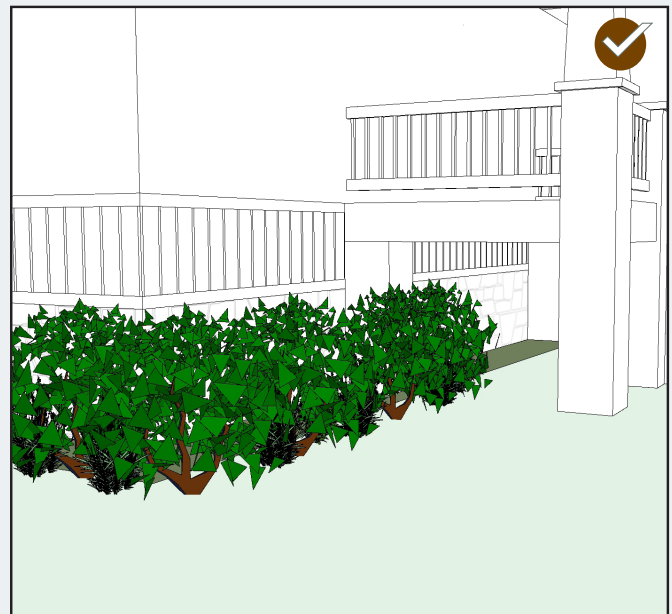

Low-scale plantings screen the raised portion of the foundation.

Low Impact Development (LID)

Low Impact Development (LID) is a strategy that addresses stormwater runoff at the source, closely mimicking the natural, pre-development, hydrologic systems rather than building infrastructure to handle runoff. LID principles increase the environmental benefits of a development, and are fiscally beneficial to communities.

For more information on LID, please see the following resources:

To learn more about Low Impact Development (LID) principles, the importance of incorporating them into a project and the economic and environmental benefits of LID features, visit the following websites and documents:

Town of Ross Stormwater Management Chapter 15.54

https://www.townofross.org/sites/default/files/fileattachments/administration/page/247/15.54_stormwater_management.pdf

Bay Area Stormwater Management Association

<http://basmaa.org/>

Marin County Stormwater Program

<https://www.marincounty.org/depts/pw/divisions/creeks-bay-and-flood/mcstoppp>

California LID Portal (from the California Stormwater Quality Association):

<https://www.casqa.org/resources/california-lid-portal>

Toolbox (from the California Stormwater Quality Association):

<https://www.casqa.org/resources/lid/toolbox>

“Reducing Stormwater Costs through Low Impact Development (LID) Strategies and Practices”:

https://www.casqa.org/sites/default/files/downloads/epa_2007_-_reducing_stormwater_costs_through_lid.pdf

“Low Impact Development Technical Design Manual”:

<http://srcity.org/1255/Low-Impact-Development>

CASQA’s Best Management Practices Handbooks:

<https://www.casqa.org/resources/bmp-handbooks>

Caltran’s Standards for Stormwater Management:

<http://dot.ca.gov/des/oe/construction-contract-standards.html>

CHAPTER 5

BUILDING DESIGN GUIDELINES



Introduction

This chapter provides design guidelines for building design. It addresses the visual character of a structure, including the arrangement and design of architectural features, overall scale, massing and the relationship to surrounding development. It also includes color, building materials and guidelines for secondary structures.

In This Chapter

Introduction	63
Building Mass, Scale and Articulation	64
Roof Form	68
Materials and Color Palette	69
Facade Design	70
Secondary Structure and ADU Design	76
Sustainable Building Design	77



Vary the massing of a building to reduce its perceived size.

Building Mass, Scale and Articulation

The overall size, height and form of a building influence how it is perceived. Although a structure may be larger than adjacent ones, it should not be monolithic in scale or create a jarring contrast, especially in contexts where the street grid and relationship between adjacent buildings is a key feature.

In order to reduce the perceived mass and scale of a building, a variety of articulation techniques can be applied. These include changes in materials, color, wall plane offsets, one-story elements and other devices that reduce the perceived size of a building. Some methods reduce the perceived building mass, while others reduce the actual building mass and scale. Where a building is located near a shared lot line, variation in massing may be particularly important. Potential articulation methods are shown in Figures 5.1 and 5.2.

- 5.1 *Design a new building to be simple in mass and form.*
 - a. While variation in mass and form can help to reduce perceived scale, an overly busy form should be avoided.

- 5.2 *Design a new building to be in scale with adjacent buildings.*

* This is particularly important for buildings that are visible from the public realm and that are in contexts with smaller lots, including the Constrained Grid Neighborhood and the Strong Street Relationship/Flat contexts.



Design a new building to be in scale with adjacent buildings. The new building above (shown in turquoise) is out of character because it appears much larger than the houses in the surrounding context.

5.3 Vary the massing of a building to reduce its perceived size.

- a. Consider using one or more of the articulation methods shown in Figures 5.1-5.4.

5.4 Establish a sense of human scale in a building.

- a. Use vertical and horizontal articulation techniques to provide a human scale and to create visual interest.
- b. Use materials that convey scale in their proportion, detail and form.

5.5 Maintain established development patterns through the use of similar building widths along the street.

- a. Design a new building to reflect the established range of building widths that occur on a block.
 - * This is particularly important in the Constrained Grid Neighborhood and Strong Street Relationship/Flat contexts.
- b. Where a building design exceeds the traditional width, indicate the traditional width with a change in material or a change in wall planes.



Establish a sense of human scale in the design of a building. The building above incorporates a one-story porch to convey a pedestrian scale.



Use vertical and horizontal articulation design techniques to provide a human scale and to create visual interest.



Maintain established development patterns through the use of similar building widths along a street.



Where a building is located near a shared rear or side lot line, variation in massing may be particularly important to avoid looming impacts.

Figure 5.1: Front Wall Articulation Methods

The following models illustrate potential ways to reduce the perceived mass of a building and to relate to the scale of adjacent buildings. A photo accompanies each model to show a built example of the articulation method. Other methods not listed here may be appropriate as well.

Front Wall Offset

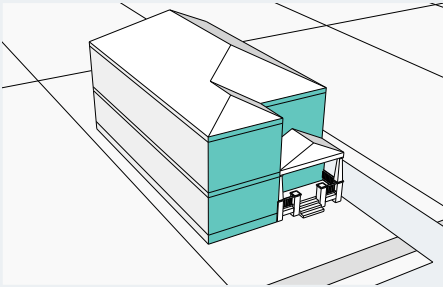

Front Wall One-Story Element

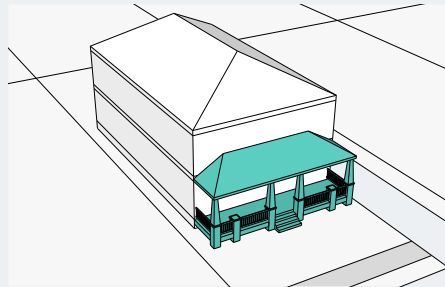

Front Wall Stepback

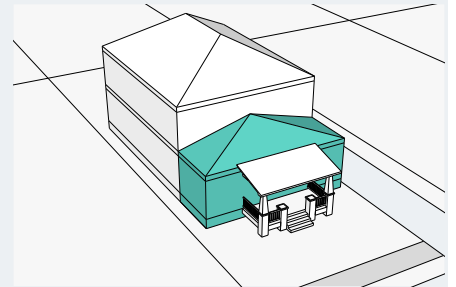
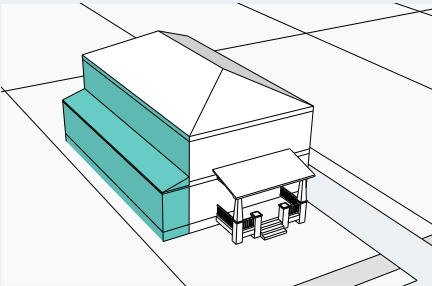
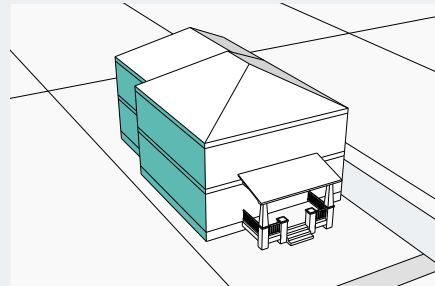

Figure 5.2: Side Wall Articulation Methods

Side Wall Stepback



Side Wall Offset



Side Wall Plane Change

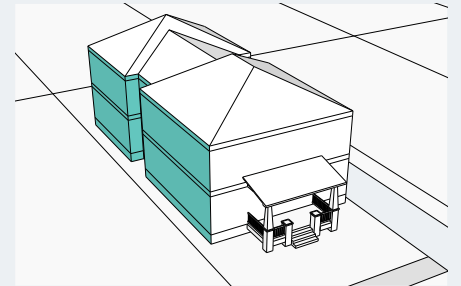
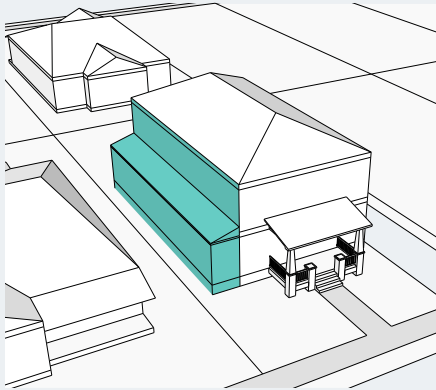

Figure 5.3: Side Massing Sensitivity Methods

The following articulation models illustrate ways in which a building located near a shared side lot line can respect the privacy of the neighboring property.

Side Wall Stepback



A side wall stepback reduces the presence of an upper-story mass along the shared lot line.

Side Wall Offset

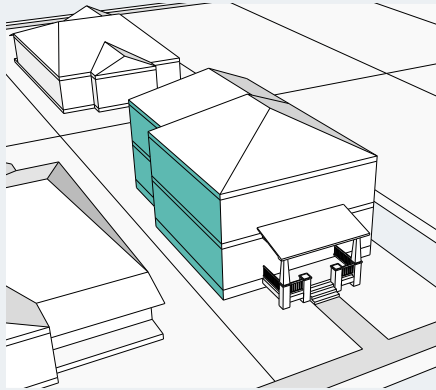

A side wall offset reduces the full, two-story mass at the shared lot line and decreases the amount of building that may loom over a neighboring structure.

Side Wall Balcony

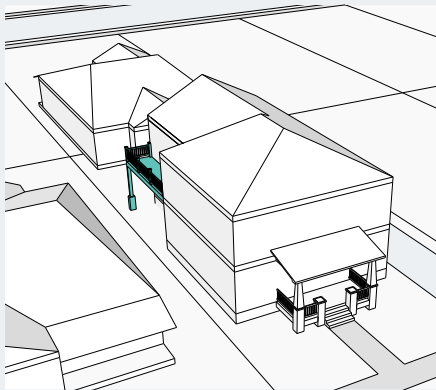

A side balcony incorporates a side wall offset in which the balcony fits. While activity will still occur in the balcony space, the presence of a balcony is less invasive than a full second-story that abuts an adjacent property line.

Side Wall Landscaping

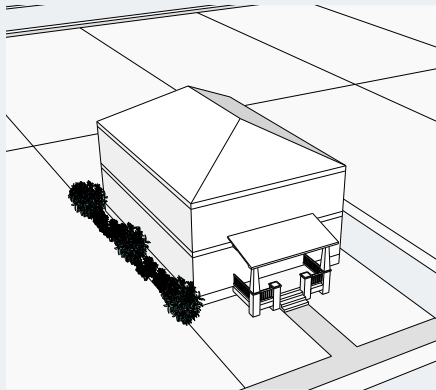

Side wall landscaping provides a visual barrier between adjacent structures. *Landscaping should also comply with Wildland Urban Interface standards.

Figure 5.4: Rear Massing Sensitivity Methods

These articulation models illustrate ways in which a building built near a shared rear lot line can respect the privacy of a neighboring property.

Rear Wall Stepback

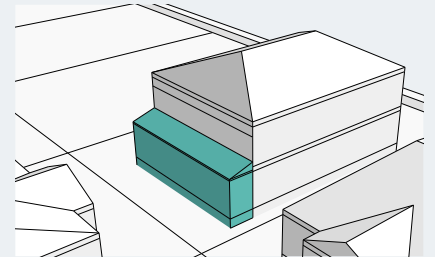

A rear wall stepback reduces the second-story mass.

Rear Wall Balcony

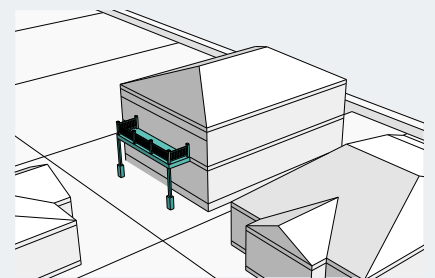

A rear wall balcony provides additional distance between buildings while still providing outdoor space.

Rear Wall Landscaping

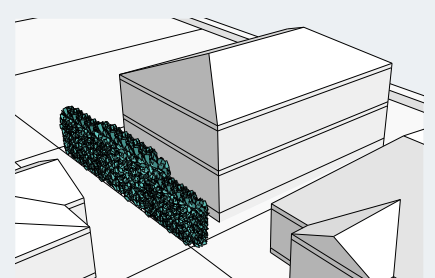

Rear wall landscaping can provide a visual buffer. *Landscaping should also comply with Wildland Urban Interface standards.



Design a roof to be generally compatible in massing and form to buildings in the context.

Roof Form

Roof form addresses the pitch, orientation and shape of a building's roof. The roof should be integrated with the overall design of a building. It should be compatible in mass and scale with other roofs in the neighborhood.

- 5.6 *Design a roof to be consistent with the overall architectural design and detailing of the structure.*
 - a. Use angles, pitches and materials that coordinate with a building's overall design.
- 5.7 *Design a roof to be compatible in massing and form to those of buildings in the block.*
 - a. Where a variety of roof forms are prevalent in a context, more variety in roof form is appropriate.



Design a roof to be consistent with the overall architectural design and detailing of the structure in terms of the form and material.

Figure 5.5: Appropriate Roof Forms

The roofs below show common forms in Ross. Other forms may be compatible if they meet the Roof Form intent statement above. Consult with Town staff about the use of alternative roof forms.

Gable



Flat



Hipped



Shed

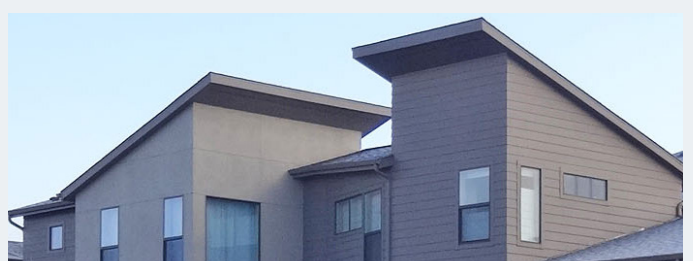

Materials and Color Palette

Building materials provide a sense of scale, texture and visual interest. Building materials can contribute to visual continuity in a context area and create texture, depth of detail and shadow on a building.

- 5.8 *Use exterior materials to create visual interest as viewed from the public realm.*
 - a. In areas where compatibility is important, use a material that is compatible in visual character, pattern and texture with those of neighboring properties.
 - b. Limit the number of materials so that the building does not look overly complex.

- 5.9 *Use high quality materials that are proven durable in Ross's climate.*
 - a. Select materials that have proven durability under high amounts of sun exposure.

- 5.10 *Use building colors that are compatible with those seen traditionally in Ross.*
 - a. Incorporate a natural color palette in hillside contexts.
 - b. Avoid overuse of sharp or overly bright colors.



Use exterior materials that create visual interest from the public realm and that are compatible with adjacent properties and the block.

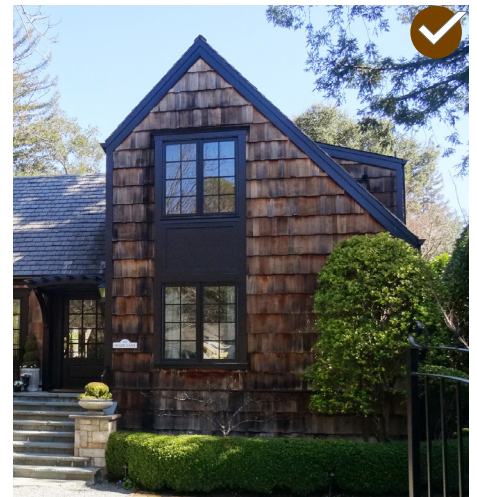

Encourage building colors that are visible from the street to be generally compatible with those seen traditionally in Ross.

Figure 5.6: Potential Building Materials

The materials shown below are potential ones for single-family residential development in Ross. Others that meet the intent and design guidelines described above are also appropriate.



Stucco



Wood



Masonry, such as stone or brick



Create a visually interesting facade through the use and arrangement of windows, entrances, materials and other architectural elements.



On sloping sites provide visual interest to the primary facade design that is visible from the street.

Facade Design

The primary facade of a home should provide a sense of a connection to the street. This may occur by arranging entrances, windows, materials and other architectural elements to provide visual interest. Large expanses of unarticulated or blank wall facing the street should be avoided. These elements should be arranged in ways similar to the patterns established on surrounding buildings.

5.11 *Create visual interest on a wall facing the street with windows, entrances, materials and other architectural elements.*

- a. Incorporate windows and doors that face the street.
- b. Incorporate a porch or other clearly defined entryway that faces the street.

5.12 *Provide a sense of visual permeability with doors and windows.*

- * This is more critical when a building is located close to the street, which often occurs in the Constrained Grid Neighborhood and Strong Street Relationship/Flat contexts.



Create a visually interesting facade through the use and arrangement of windows, entrances, materials and other architectural elements.

Entry Design

The building entry is a critical link between the public and private realm. The key is to create a clear visual and physical linkage, so the primary entrance to a building is clearly identifiable. In some contexts, this is best accomplished with a front porch, patio, stoop or otherwise highlighted entryway. In other contexts where the building may be set back farther from the street or is located on steep topography, a primary entrance may not be visible from the street. In these cases, other options may be utilized to create a sense of connection with the street. A well-defined path or an arbor entry is an example. For more information on arbor entries and front yard design, please see the site design chapter.

5.13 *Design a primary entrance to create a visual and physical connection to the street. Potential methods include:*

- a. Orient the element towards the public realm.
- b. Potential elements to incorporate include:
 - Porch
 - Portico
 - Stoop
 - Canopy/Overhang
 - Building recess
 - Moldings

5.14 *Size and proportion an entry element to be in scale with those of nearby buildings.*

- a. This is particularly important in the Constrained Grid Neighborhood and Strong Street Relationship/Flat contexts.

5.15 *Design a first-story element to be similar in size, location and proportion to those of homes in the context.*

- a. Where possible, locate a first-story element to align with those seen on neighboring properties.

5.16 *Design a porch to be functional, with a minimum depth of 5'.*



Design a primary building entrance to create a visual and physical connection to the street.

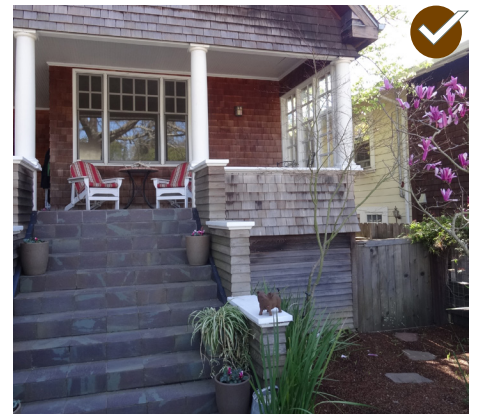

Use an architectural element, such as a stoop or porch, to highlight an entrance.



Size and proportion an entry element to be in the range of scales seen on nearby buildings.

Figure 5.7: Recommended Building Entry Location and Character

The location of the primary entrance of a building varies among residential contexts in Ross. In many neighborhoods, there is a consistency in the way in which entrances are designed, and maintaining these patterns is an objective. In other neighborhoods, more diversity exists in the way in which entrances are designed and, therefore, more variety is appropriate. This table identifies alternative entry locations for a residence. Other designs that are not illustrated here may also be appropriate, when they are consistent with the context.

Covered Porch Entry Centered on the Facade

The primary entrance to the home is located on the front wall and faces the street. A covered, projecting porch defines the entrance.

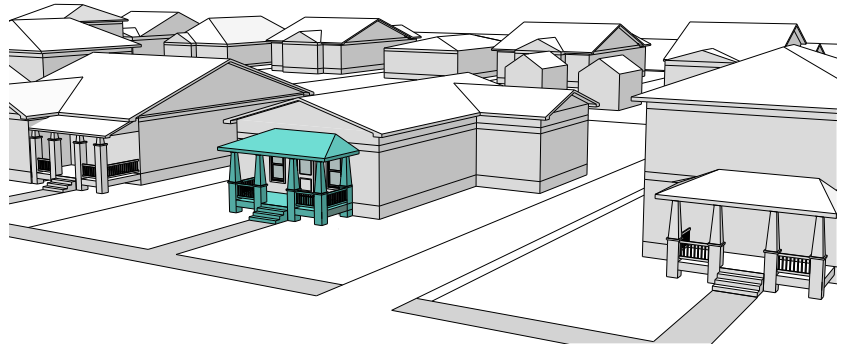

Covered Porch Entry on Side of the Facade

The primary entrance is perpendicular to the street, and opens onto a porch that faces the street. The recessed porch defines the entrance.

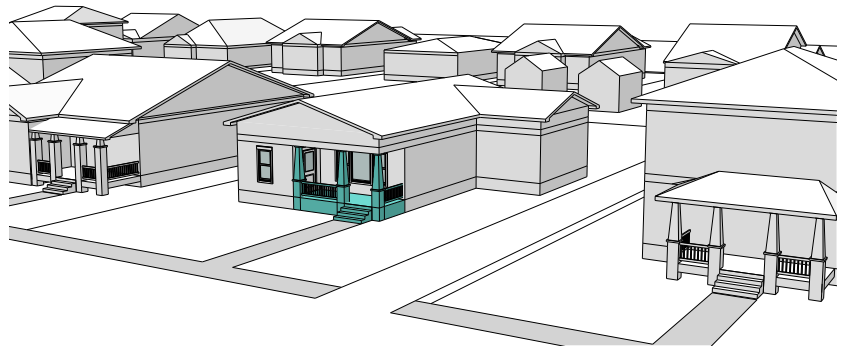

Covered Porch Entry Along Side Wall

The primary entrance is located along a sidewall and opens onto a porch, which defines the entrance.

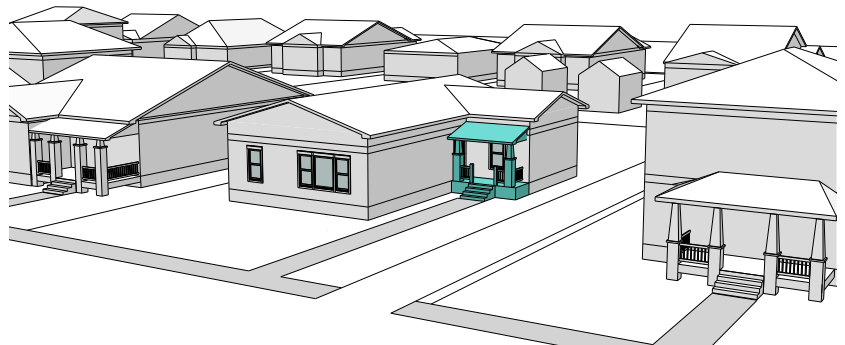

Doors

A street-facing door provides a key visual connection between the public and private realms. This enhances walkability and street level interest. The door should be easily recognizable and in scale.

5.17 *Design the primary entrance of a home to be clearly identifiable. Consider:*

- a. Change in color and material of the door and/or surrounding materials (such as trim or moldings)
- b. Accent windows such as a transom or sidelight

5.18 *Size a door to be easily readable and recognizable, and to be in proportion to the scale of the house.*

5.19 *Design a door to be consistent with the overall style of the building.*



Size a door to be easily readable and recognizable, but not to be overly large.

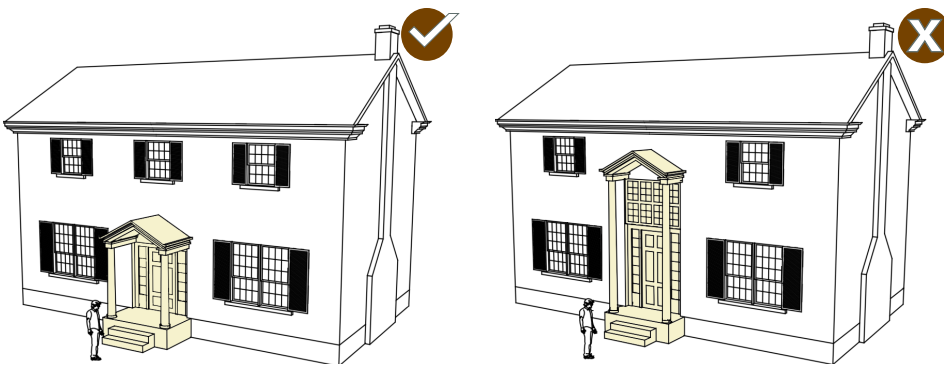

Size a door to be easily recognizable, and to be in proportion to the house. The illustration on the left shows a door that is in scale with the building. The building on the right has a door that is too large for the home.

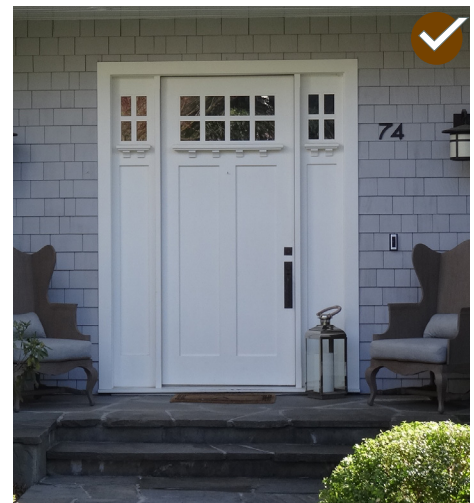

Design a door as part of the overall style of the building.



Windows

Windows are key design elements for residential buildings, providing a balance of solid to void. They also create a visual connection between the public realm and a building with “eyes on the street.” Where compatibility within a context is important, consider the window patterns, proportions and transparency levels of neighboring homes when deciding on window sizes and placement.



Locate windows to create visual interest along a street.

5.20 *Locate windows to create visual interest along a street.*

- a. Encourage the use of windows that create a sense of depth, profile and shadow on a street-facing wall.

5.21 *Design a window to be proportional to the size and character of the building.*

- a. Size and proportion a window to be in the range of heights and widths of windows seen traditionally in the block.



Size and proportion a window to be in the range of heights and widths of windows seen traditionally in the block.



Locate and space windows to express a traditional rhythm and create visual continuity.

Architectural Detailing

Detailing helps create visual interest and convey a sense of craftsmanship, while reducing a building's perceived size. This can be accomplished with ornamentation, layering of materials and patterns or simple accent lines. Detailing should create contrast, shadow lines and visual interest. Thoughtful detailing is important throughout all contexts areas.

5.22 Use detailing to create interest and provide a sense of scale. Appropriate techniques include:

- Accent lines
- Ornamentation
- Color/material change
- Minor wall offsets
- Eaves and overhangs
- Window and door framing details
- Exterior or building lighting



Use detailing to create interest and provide a sense of scale.



Because thoughtful detailing is a common feature of homes in Ross, it is important throughout the various context areas.



Detailing helps create visual interest and a sense of craftsmanship, while reducing a building's perceived size.



Use materials that are visually subordinate to the materials on the primary structure, or materials that are visually compatible with those of the primary structure.



Use materials and finishes compatible with the primary building.



Use an arbor entry to help mitigate the visual impact of a garage door.



When feasible, use separate, single-car entrance doors rather than a single two-car or (three-car) entrance door.

Secondary Structure and ADU Design

Secondary structures, such as detached garages, sheds and studio spaces, and Accessory Dwelling Units (ADUs) provide important spaces for many people. They should be subordinate to the primary structure. When visible from the public realm, a secondary structure or ADU should be visually compatible with the primary structure to maintain a cohesive look. (More flexibility may be appropriate where a secondary structure or ADU is hidden from the view of the street.) Their design encompasses exterior materials, door design, window openings, scale and massing.

- 5.23 *Design a secondary structure and ADU to be subordinate to, and compatible with, the primary structure, when it will be visible from the street.*
- Use materials and finishes compatible with the primary building.
 - Use exterior materials that are compatible with context.

- 5.24 *When designing a garage:*
- Use detail on a garage door to break up its perceived mass.
 - When feasible, use separate, single-car entrance doors rather than a single two-car entrance door.
 - Use an arbor entry or architectural detail (such as an overhang), to help mitigate the visual impact of a garage door.



If visible from the public realm, design an ADU to be subordinate to the primary structure. Some options are locating the ADU in the rear and making it smaller in size.



Design a secondary structure or garage to be visually compatible with the primary structure to maintain a cohesive look.

Sustainable Building Design

Buildings in Ross should incorporate sustainable design features whenever possible to reduce environmental impacts and conserve energy. Each design should incorporate sustainability features and technologies that maximize energy efficiency and address seasonal changes in natural lighting and ventilation conditions.

5.25 Choose a material that reduces energy consumption.

- a. Use a local, recycled material where possible.
- b. Use a light colored surface material that reflects heat.
- c. Consider incorporating an energy-generating feature on a site. This may include a freestanding solar panel, solar powered lighting or similar feature.
- d. Consider incorporating a living roof.

5.26 When redeveloping a site, salvage or reuse materials where possible.

- a. Incorporate a functional existing building into a redevelopment project in order to minimize waste and greenhouse gas emissions associated with demolition.



Use exterior materials that are compatible with context.

Green Building

Information on Green Building can be found on the Marin County Website.

<https://www.marincounty.org/depts/cd/divisions/sustainability/green-building-program>



Consider incorporating a living roof.



Locate attached or detached solar technologies, such as solar panels and solar cells, where sun will be harvested, as well as where technologies are least visible from the public realm.

- 5.27 Consider a design feature that conserves energy.**
- a. Utilize external shading (landscape and/or integrated into the building) to keep out summer sun and let in winter sun.
 - b. Design windows to maximize light into interior spaces.
 - c. Use exterior shading devices, such as overhangs, to manage solar gain in summer months and welcome solar access in winter months.
 - d. Incorporate a renewable energy device, including a solar collector or wind turbine.

- 5.28 Incorporate solar-oriented, energy-generating technologies in a building.**
- a. Locate attached or detached solar technologies, such as solar panels and solar cells, where sun will be harvested.

- 5.29 Locate an energy generating device, such as solar panels, to be subordinate to prominent architectural features.**
- a. Choose a solar panel that includes a low amount of visual contrast in its design and color to the roof.
 - b. Locate a solar panel to the rear portion of a roof or on a secondary structure to minimize its visual impact on the public realm.

CHAPTER 6

TREATMENT OF HERITAGE RESOURCES



Many buildings in Ross reflect the early development of the community, and could be considered to have historic significance. While they may not be formally designated as historic resources, they are a part of the culture of the community. In that sense, the guidelines that follow address these properties as “heritage resources.” Many property owners will seek to preserve these properties. (Note that no formal register of historic properties exists in Ross but many properties are valued for their historic character.)

This section provides guidelines that owners may elect to use when making improvements to these heritage properties. Compliance with the guidelines in this section is not required, but may help owners of heritage properties make decisions about building and site improvements or renovations. This section may also help the Town to formulate a strategy for formal historic preservation if it decides to pursue such a program in the future.

In This Chapter

Heritage Preservation Principles and Best Practices	80
Approaches to Heritage Preservation Projects	82
Guidelines for the Treatment of Heritage Building Features	83



Respect the original design character of the building.

Heritage Preservation Principles and Best Practices

When considering a project involving heritage resources, a set of preservation principles applies regardless of project type or property type. Consider the following principles:

Respect the original design character of the building.

Do not try to change the style of a heritage resource or make the structure look older than its actual age. Confusing the character by mixing elements of different styles can weaken the appearance and quality of the structure. Likewise, when constructing an addition, do not try to emulate a traditional style to make the addition look older than its actual age. An addition should relate to the original building in general massing and scale, but should be distinguishable. An addition should be designed and located to be subordinate to the original structure. It should be located to the rear of the original structure whenever possible, and to the side when the rear is not possible, in order to minimize the visibility of the addition.

Protect and maintain significant features and stylistic elements.

Distinctive stylistic features or examples of skilled craftsmanship should be treated with sensitivity. The best preservation procedure is to maintain heritage features from the outset to prevent intervention. Protection includes the maintenance of traditional material through treatments such as rust removal, caulking, limited paint removal and reapplication of paint.

Preserve any existing original site features or original building materials and features.

Preserve original site features wherever possible and maintain them to avoid deterioration. Avoid removing, altering, obscuring or covering an original material or feature.

Repair deteriorated features and replace only those elements that cannot be repaired.

Upgrade existing materials, using recognized heritage preservation methods wherever possible. If disassembly is necessary for repair or restoration, use methods that minimize damage to original materials and the replacement of original configuration. Any repair should be done with sensitivity to the integrity of the building, existing design and character-defining features.

Design additions and alterations to a heritage structure to respect it and maintain its integrity.

When constructing an addition, do not try to emulate a traditional style to make the addition look older than its actual age. A contemporary design for an alteration or addition to a heritage structure should not be discouraged as long as it does not destroy character-defining features of the heritage structure and as long as the design is compatible with the heritage structure. Wherever possible, a new addition or alteration to a heritage structure should be done in such a manner that if it were to be removed in the future, the essential form and integrity of the structure would be unimpaired.

FIGURE 6.1: PREFERRED SEQUENCE OF TREATMENTS FOR A HERITAGE RESOURCE

Treatment 1: Preserve

If a feature is intact and in good condition, maintain it as such.



Treatment 2: Repair

If the feature is deteriorated or damaged, repair it to its original condition.



Treatment 3: Reconstruct

If the feature is missing entirely, reconstruct it from appropriate evidence. If a portion of a feature is missing, it can also be reconstructed.



Treatment 4: Replace

If it is not feasible to repair the feature, then replace it with one that is a simplified interpretation of the original (i.e., material, detail, finish). Replace only that portion which is beyond repair.



Treatment 5: Compatible Alteration

If a new feature or addition is necessary, design it in such a way as to minimize the impact on original features. It is also important to distinguish new features from traditional elements.

Approaches to Heritage Preservation Projects

Preservation projects may include a range of activities, such as the maintenance of existing heritage elements, repairs of deteriorated materials, the replacement of missing features and the construction of new additions. When planning a preservation approach, consider the following treatments of a heritage resource to determine which is appropriate to the project.

Preservation

The act or process of applying measures to sustain the existing form, integrity and material of a building. Some work focuses on keeping a property in good working condition by repairing features as soon as deterioration becomes apparent, using procedures that retain the original character and finish of the features. Property owners are strongly encouraged to maintain properties in good condition.

Rehabilitation

The process of returning a property to a state that makes a contemporary use possible while still preserving those portions or features of the property which are significant to its traditional, architectural or cultural values. Rehabilitation may include a change in use of the building or additions.

Renovation

The process of improving by repair, to revive, a building. In renovation, the usefulness and appearance of the building is enhanced. The basic character and significant details of a building are respected and preserved, but some sympathetic alterations may also occur.

Restoration

The process of reproducing the appearance of a building exactly as it looked at a particular time. This may include the removal of later work or the replacement of missing heritage features.

Remodeling

The process of changing the traditional design of a building. The appearance is altered by removing original details and by adding new features that are out of character with the original. Remodeling of a heritage structure is inappropriate due to the loss of original fabric.

Reconstruction

The process of rebuilding a structure that no longer exists exactly as it appeared traditionally.

Guidelines for the Treatment of Heritage Building Features

Individual architectural features, building elements and materials of a heritage structure create the character of the structure. Therefore, meticulous care and proper treatment of each feature is crucial to maintaining the character of a heritage structure.

Character-Defining Features

Character-defining features contribute to the design of a structure. Select an appropriate treatment that will provide for proper preservation of significant features. The method that requires the least intervention is preferred.

- 6.1 *Preserve a key character-defining feature.*
 - a. Cornices, porches, turned columns, brackets, exposed rafter tails and jigsaw ornaments are examples of character-defining features that should be preserved.
 - b. Do not remove or alter features that are in good condition or that can be repaired.
- 6.2 *Repair a deteriorated character-defining feature.*
 - a. Patch, piece-in, splice, consolidate or otherwise upgrade existing materials, using recognized preservation methods.
 - b. Removing a damaged feature that can be repaired is not appropriate.
- 6.3 *When disassembly of a historic feature is necessary for its repair, use methods that minimize damage to it.*
 - a. When removing a heritage feature, document its location so it may be repositioned accurately.
- 6.4 *Use technical procedures for cleaning, refinishing and repairing character-defining features that will maintain the original finish.*
 - a. Use the gentlest means possible that will achieve the desired results.
 - b. Employ treatments such as rust removal, caulking, limited paint removal and reapplication of paint or stain where appropriate.



Preserve a key character-defining feature.

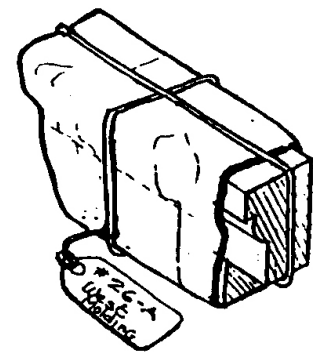

When disassembly of a heritage feature is necessary for its repair, document its location so it may be repositioned correctly.

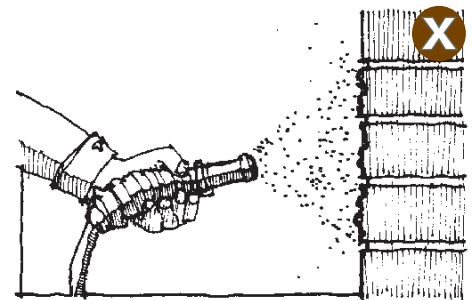

Use approved technical procedures for cleaning, refinishing and repairing traditional materials. As shown here, harsh cleaning methods, such as sandblasting or grinding are inappropriate.

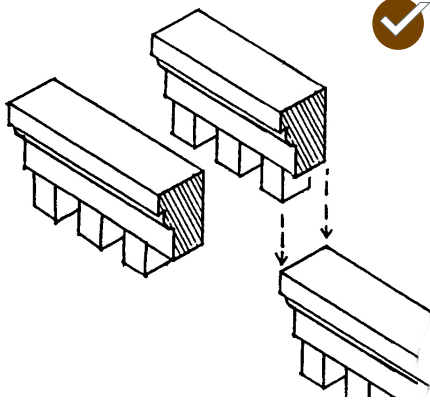

Where replacement of an element is required, remove only those portions that are deteriorated beyond repair.

- 6.5 *Replace a character-defining feature accurately.*
- The design should be substantiated by physical or pictorial evidence to avoid creating a misrepresentation of the building's history.
 - Use the same kind of material as the original when feasible. However, a substitute material may be acceptable if the size, shape, texture and finish conveys the visual appearance of the original. Alternative materials are usually more acceptable in locations that are remote from view or direct contact.
 - Restore altered openings on primary facades to their original configuration, when feasible, using historic photos.
- 6.6 *When reconstructing an element is impossible, develop a new design that is a compatible interpretation of it.*
- The new element should be similar to comparable features in general size, shape, texture, material and finish.
- 6.7 *Avoid adding an architectural detail, such as a bracket or an intricate balustrade, that was not part of the original building.*
- For example, decorative millwork should not be added to a building if it was not an original feature. Doing so would convey a false history.

Roof

The character of a heritage roof should be preserved, including its form and materials, whenever feasible.

6.8 Preserve the original roof form of a heritage structure.

- a. Avoid altering the angle of a heritage roof. Instead, maintain the perceived line and orientation of the roof as seen from the street.

6.9 Preserve the original eave depth of a roof.

- a. The shadows created by traditional overhangs contribute to one's perception of the building's traditional scale and therefore, these overhangs should be preserved. Cutting back roof rafters and soffits or in other ways altering the traditional roof overhang is inappropriate.

6.10 Preserve a decorative and functional roof feature.

- a. Preserve decorative elements, including crests.
- b. Retain and repair functional roof features, including chimneys, half-round gutters, boxed soffits and downspouts.

6.11 Employ new roof materials that convey a scale and texture similar to those used traditionally.

- a. When choosing a roof replacement material, consider the architectural style of the structure.
- b. Composition shingle roofs are generally appropriate replacements for wood shingles on residential buildings.
- c. Shingles that contain embedded photovoltaic systems are also appropriate in dark colors.

6.12 Minimize the visual impact of skylights and other rooftop devices.

- a. A skylight that is flush with the roof plane may be considered where it remains visually subordinate.
- b. Skylights should not interrupt the plane of the heritage roof, and should be located below the ridgeline.
- c. Locate electronic data transmission and receiving devices to minimize impacts to the extent feasible.

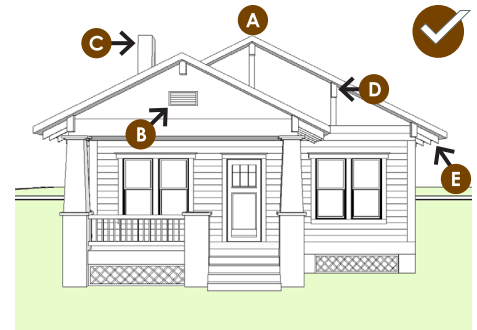

- A** Gable or Hip Roof Form
- B** Attic Vent or Window
- C** Chimney
- D** Decorative Roof Beam
- E** Exposed Rafter Tail

Preserve a decorative and functional roof feature.

Doors

The character-defining features of a heritage door and its distinct materials and placement should be preserved. When a new door is needed, it should be in character with the building. This is especially important on primary facades.

- 6.13 *Preserve the decorative and functional features of a primary entrance.*
 - a. These include the door, door frame, screen door, threshold, glass panes, paneling, hardware, detailing, transoms and flanking sidelights.
 - b. Avoid changing the position of an original front door.
- 6.14 *Maintain the original proportions of a traditionally significant door.*
 - a. Altering the original size and shape of a heritage door is inappropriate.
 - b. Avoid adding sidelights when not part of the original configuration.
- 6.15 *When replacing a door, use materials that appear similar to that of the original.*
- 6.16 *When replacing a door, use a design that has an appearance similar to the original door, or a door associated with the building style or type.*
- 6.17 *Do not create a new entrance on a primary elevation that was not traditionally there.*

Windows

The character-defining features of a heritage window, its distinct materials and its location should be preserved. In addition, a new window should be in character with the heritage building.

6.18 *Preserve the functional and decorative features of a heritage window.*

- a. Features important to the character of a window include its frame, sash, muntins, mullions, glazing, sills, heads, jambs, moldings, operation and groupings of windows.
- b. Repair frames and sashes rather than replacing them, whenever possible.

6.19 *Preserve the position, number and arrangement of heritage windows in a building wall.*

- a. On primary facades, enclosing a heritage window opening is inappropriate, as is adding a new window opening.

6.20 *Preserve the ratio of window openings to solid wall on a primary facade.*

- a. Significantly increasing the amount of glass on a character-defining facade will negatively affect the integrity of the structure.

6.21 *Preserve the size and proportion of a heritage window opening.*

- a. Reducing an original opening to accommodate a smaller window or increasing it to receive a larger window is inappropriate.
- b. Avoid converting an original window to a door on a visible facade.

6.22 *Match a replacement window to the original in its design.*

- a. Maintain the size of the original window opening.
- b. If the original is double-hung, then the replacement window should also be double-hung or appear to be so. Match the replacement also in the number and position of glass panes.
- c. Matching the original design is particularly important on key character-defining facades.



Preserve the functional and decorative features of a heritage window including the frame, sash, muntins, mullions, glazing, sills, heads, jambs, moldings, operation and groupings of windows.



Preserve the position, number and arrangement of heritage windows in a building wall.

- 6.23 *In a replacement window, use materials that appear similar to the original.*
- Using the same material as the original is preferred, especially on street-facing facades. A substitute material may be considered if the appearance of the window components will match those of the original in dimension, profile and finish. However, vinyl is inappropriate.
 - New glazing should convey the visual appearance of traditional glazing. It should be clear. Transparent low-e type glass is appropriate. Metallic and reflective finishes are inappropriate.
- 6.24 *Match, as closely as possible, the profile of the sash and its components to that of the original window.*
- A traditional wood window usually has a complex profile. Within the window's casing, the sash steps back to the plane of the glazing (glass) in several increments. These are important details that distinguish the actual window from the surrounding plane of the wall and this practice should be continued.
- 6.25 *Convey, as closely as possible, the character of traditional sash divisions in a new window.*
- Muntins that divide a window into smaller panes of glass should be genuine on key facades and other highly visible places.
 - Snap-on muntins located on the outside of a window may be used in secondary facades but should have a similar depth and shadow line.
 - Strips of material located between panes of glass to simulate muntins are inappropriate.
- 6.26 *When installing a new window, locate it on a rear or other non-character defining elevation.*
- 6.27 *Where necessary, provide a setback in the design of dropped ceilings, during an interior renovation, to allow for the full height of existing window openings.*

Porches

A porch is one of the most important character-defining elements of a residential structure. It provides visual interest and influences perceived scale. Preserve a porch in its original condition and form.

6.28 *Maintain an original porch when feasible.*

- a. Maintain the existing location, shape, details and posts of the porch.
- b. Missing or deteriorated decorative elements should be replaced to match existing elements; e.g., match the original proportions and spacing of balusters when replacing missing ones.
- c. If enclosing a traditional porch is desired, enclose it in a manner that preserves the character of the original porch and building. For instance, this could include large sheets of glass and recessing the enclosure well behind the existing scrollwork, posts and balustrades.

6.29 *Repair those elements of a porch that are deteriorated.*

- a. Removing damaged materials that can be repaired is not appropriate.

6.30 *If a porch has been altered, consider restoring it back to its original design.*

- a. If the traditional design of the porch is unknown, then base the design of the restoration on other traditional porches on buildings of a similar architectural style.

6.31 *When replacing a porch is necessary, design it to be similar in character, design, scale and materials to those seen traditionally.*

- a. The size of a porch should relate to the overall scale of the primary structure to which it is attached.
- b. Base the replacement design on historic documentation if available.
- c. Where no evidence of the traditional porch exists, a new porch may be considered that is similar in character to those found on comparable buildings.

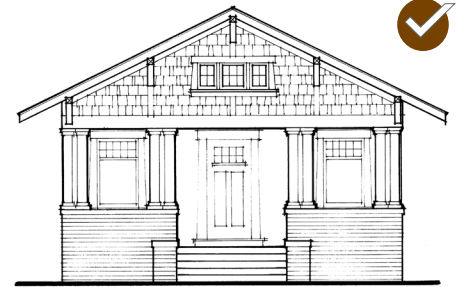

The top model illustrates a heritage, vernacular house with an original porch that has been enclosed, which is an inappropriate treatment. The bottom model illustrates a replacement porch that has been designed similarly to the original porch, which is the preferred approach, when documentation is available.

Materials

Primary heritage building materials should be preserved in place whenever feasible. If the material is damaged, then limited replacement which matches the original should be considered. These materials should never be covered or subjected to harsh cleaning treatments.

6.32 *Preserve an original building material.*

- a. Avoid removing original materials that are in good condition.
- b. Remove only those materials which are deteriorated, and must be replaced.
- c. Preserve masonry features that define the overall heritage character, such as walls, cornices, pediments, steps and foundations.

6.33 *Repair a deteriorated primary building material.*

- a. Repair by patching, piecing-in, consolidating or otherwise reinforcing the material.

6.34 *When replacing materials on primary surfaces, match the original material in composition, scale and finish.*

- a. If the original material is wood clapboard, for example, then the replacement material should be wood as well. It should match the original in size, the amount of exposed lap and in finish.
- b. Replace only the amount required. For example, if a few boards are damaged beyond repair, then only they should be replaced, not the entire wall.
- c. Do not strip traditionally-painted wood surfaces to bare wood to achieve a “natural look.”

- 6.35 *Do not use synthetic materials, such as aluminum, vinyl or panelized brick, as replacements for primary building materials.*
- a. Do not replace primary building materials, such as wood siding and masonry, with synthetic materials.
 - b. Do not use modular materials as replacement materials. Synthetic stucco and panelized brick, for example, are inappropriate.
- 6.36 *Covering an original building material with a new material is inappropriate.*
- a. Vinyl siding, aluminum siding and new stucco are generally inappropriate on heritage buildings. Other imitation materials that are designed to look like wood or masonry siding, fabricated from other materials, are also inappropriate.
- 6.37 *Consider removing later covering materials that have not achieved heritage significance.*
- a. Once the non-heritage siding is removed, repair the original, underlying material.
 - b. If a structure has a stucco finish, removing the covering may be difficult, and may not be desirable. Test the stucco to assure that the original material underneath will not be damaged.



Contemporary interpretations of traditional fences should be compatible with the traditional context.



Design a replacement fence to be in character with the original and with those seen traditionally.



Screen pool-related mechanical equipment (such as pool pumps) to minimize their visibility.

Mechanical Equipment

The installation of mechanical equipment should not be visible on the primary facade of a heritage structure.

- 6.38 *Install heating and air conditioning units in window frames that are not on the primary facade of the heritage structure.*
- 6.39 *Screen pool-related mechanical equipment (such as pool pumps) to minimize their visibility.*

Fences

Heritage site elements, such as fences, contribute to the character of a heritage property and should be maintained. New site work that alters the heritage character of a property and its site elements should be avoided.

- 6.40 *Preserve an original fence.*
 - a. Replace only those portions that are deteriorated beyond repair.
- 6.41 *Design a replacement fence to be in character with the original and with those seen traditionally.*
 - a. The design of a fence that defines a front yard is traditionally low to the ground and transparent in nature.
 - b. Contemporary interpretations of traditional fences should be compatible with the heritage context.
 - c. Note that using no fence at all is often the most appropriate approach.
 - d. Design a retaining wall that defines the front yard to be low to the ground.
 - e. Design a replacement retaining wall to be of materials traditionally used to construct a retaining wall.

Additions to Heritage Structures

An addition should be compatible with the primary structure and not detract from one's ability to interpret its heritage character.

6.42 *Place an addition at the rear of a building, or set it back from the front, to minimize the visual impacts.*

- a. This will allow the original proportions and character to remain prominent.
- b. Where an addition to a heritage structure is visible from the public realm, choose architectural features – such as windows and doors – that are similar in profile to the architectural features of the existing structure.

6.43 *Design a new addition to be a product of its own time.*

- a. Do not attempt to replicate the appearance of the heritage structure.

6.44 *Design a new addition to respect the mass and scale of the original structure.*

- a. An addition should be simple in design to prevent it from visually competing with the primary facade.
- b. For a larger addition, break up the mass of the addition into smaller modules that relate to the heritage house.
- c. To keep the size of a higher mass as small as possible, use a lower plate height.

6.45 *Design a new addition to respect the heritage materials and character-defining features of the heritage structure.*

- a. Do not destroy, damage or obscure original heritage materials.
- b. Do not destroy, damage or obscure heritage character-defining features.

6.46 *Utilize a roof form for a new addition that is in character with the original structure.*

- a. When constructing a rooftop addition, keep the mass and scale subordinate to the primary building.

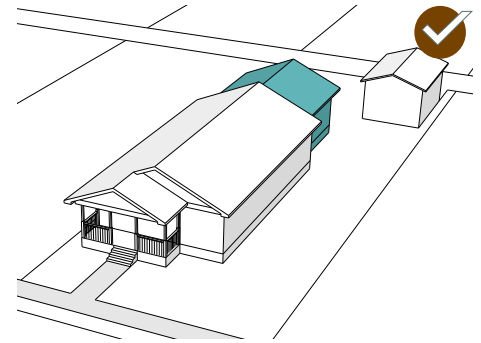

Place an addition at the rear of a building, or set it back from the front, to minimize visual impacts.

Figure 6.2: Designing an Addition to a Heritage Structure

An addition to a property should be clearly differentiated from the original structure and be subordinately scaled as illustrated below.

Original Structure

The one-and-a-half story bungalow illustrated at the right is a heritage structure.

Birds Eye View

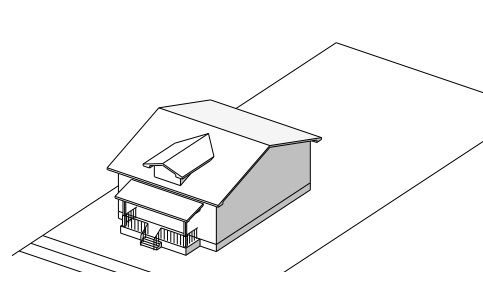

Street View

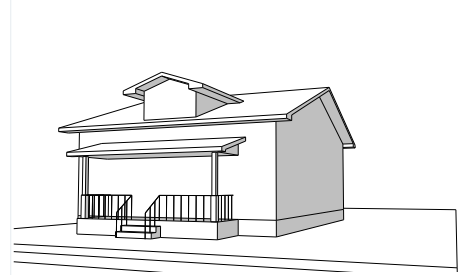

One-Story Attached Addition

A one-story addition is at the rear, and walls are set in.

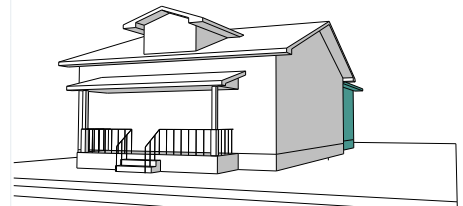
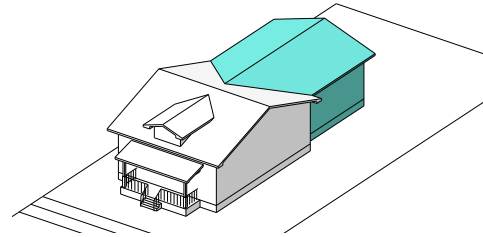

One and a Half Story Addition with Connector

The one-and-a-half story addition is appropriate because it is set back and clearly differentiated from the original structure with a connector.

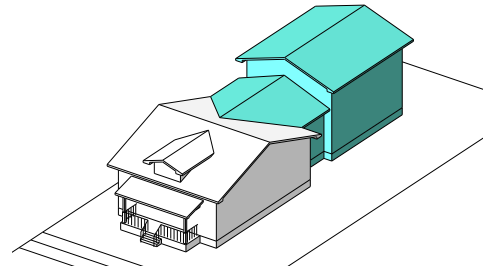

“Camelback” Style Rooftop Addition

The roof-top addition illustrated at right is appropriate because it is substantially set back from the street.

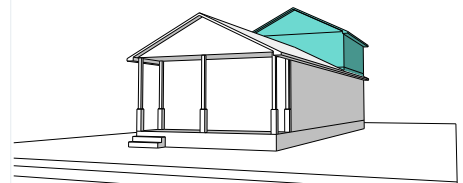
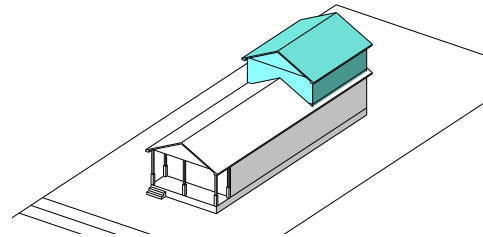

Inappropriate Two-Story Rooftop Addition

The roof-top addition is inappropriate because it substantially alters the primary facade of the heritage structure.

